

®

# MACKIE

# 8-BUS OWNER'S MANUAL

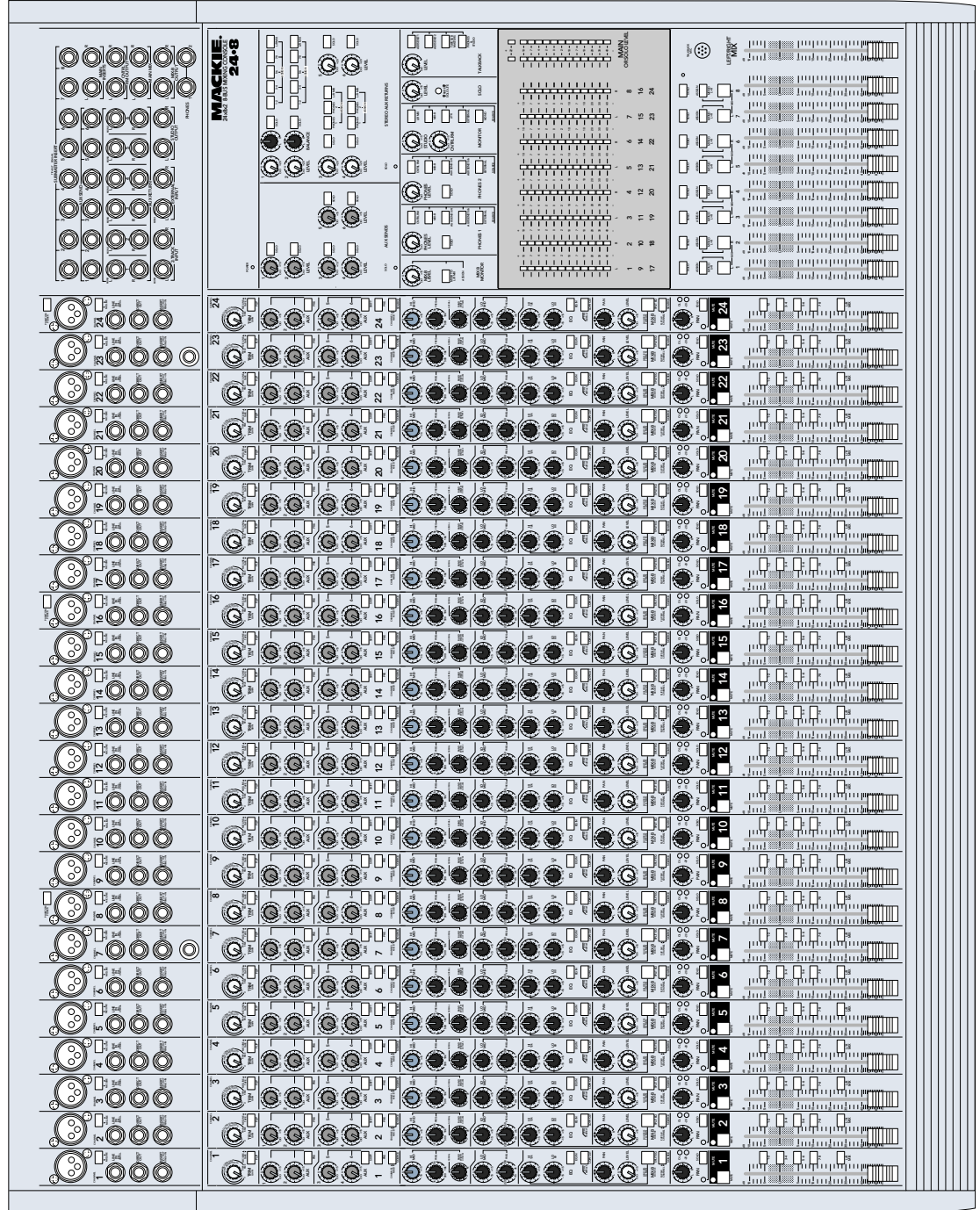

CAUTION AVIS

RISK OF ELECTRIC SHOCK  
DO NOT OPEN  
RISQUE DE CHOC ELECTRIQUE  
NE PAS OUVRIR

---

CAUTION: TO REDUCE THE RISK OF ELECTRIC SHOCK  
DO NOT REMOVE COVER (OR BACK)  
NO USER-SERVICEABLE PARTS INSIDE  
REFER SERVICING TO QUALIFIED PERSONNEL  
ATTENTION: POUR EVITER LES RISQUES DE CHOC  
ELECTRIQUE, NE PAS ENLEVER LE COUVERCLE. AUCUN  
ENTRETIEN DE PIECES INTERIEURES PAR L'USAGER. CONFIEZ  
L'ENTRETIEN AU PERSONNEL QUALIFIE.  
AVIS: POUR EVITER LES RISQUES D'INCENDIE OU  
D'ELECTROCUTION, N'EXPOSEZ PAS CET ARTICLE  
A LA PLUIE OU A L'HUMIDITE

The lightning flash with arrowhead symbol within an equilateral triangle is intended to alert the user to the presence of uninsulated "dangerous voltage" within the product's enclosure, that may be of sufficient magnitude to constitute a risk of electric shock to persons.  
*Le symbole éclair avec point de flèche à l'intérieur d'un triangle équilatéral est utilisé pour alerter l'utilisateur de la présence à l'intérieur du coffret de "voltage dangereux" non isolé d'ampleur suffisante pour constituer un risque d'électrocution.*

The exclamation point within an equilateral triangle is intended to alert the user of the presence of important operating and maintenance (servicing) instructions in the literature accompanying the appliance.  
*Le point d'exclamation à l'intérieur d'un triangle équilatéral est employé pour alerter les utilisateurs de la présence d'instructions importantes pour le fonctionnement et l'entretien (service) dans le livret d'instruction accompagnant l'appareil.*

## SAFETY INSTRUCTIONS

1. Read Instructions — Read all the safety and operation instructions before operating the 8•Bus Console and External Power Supply.
2. Retain Instructions — Keep the safety and operating instructions for future reference.
3. Heed Warnings — Follow all warnings on the 8•Bus Console and External Power Supply and in these operating instructions.
4. Follow Instructions — Follow all operating and other instructions.
5. Water and Moisture — Do not use the 8•Bus Console and External Power Supply near water - for example, near a bathtub, washbowl, kitchen sink, laundry tub, in a wet basement, near a swimming pool, swamp or salivating St. Bernard dog, etc.
6. Heat — Locate the 8•Bus Console and External Power Supply away from heat sources such as radiators, or other devices that produce heat.
7. Power Sources — Connect the 8•Bus Console and External Power Supply only to a power supply of the type described in these operation instructions or as marked on the 8•Bus Console and External Power Supply.
8. Power Cord Protection — Route power supply cords so that they are not likely to be walked upon or pinched by items placed upon or against them, paying particular attention to cords at plugs, convenience receptacles, and the point where they exit the 8•Bus Console and External Power Supply.
9. Object and Liquid Entry — Do not drop objects or spill liquids into the inside of the 8•Bus Console and External Power Supply.
10. Damage Requiring Service — The 8•Bus Console and External Power Supply should be serviced only by qualified service personnel when:

- A. 8•Bus Console and External Power Supply power-supply cord or the plug has been damaged; or
- B. Objects have fallen, or liquid has spilled into the 8•Bus Console and External Power Supply; or

- C. The 8•Bus Console and External Power Supply have been exposed to rain; or
- D. The 8•Bus Console and External Power Supply does not appear to operate or exhibits a marked change in performance; or
- E. The 8•Bus Console and External Power Supply has been dropped, or its chassis damaged.

11. Servicing — Do not attempt to service the 8•Bus Console and External Power Supply beyond those means described in this operating manual. All other servicing should be referred to the Mackie Service Department.

12. To prevent electric shock, do not use the 8•Bus Console and External Power Supply polarized plug with an extension cord, receptacle or other outlet unless the blades can be fully inserted to prevent blade exposure.

*Pour prévenir les chocs électriques ne pas utiliser cette fiche polarisée avec un prolongateur, une prise de courant ou une autre sortie de courant, sauf si les lames peuvent être insérées à fond sans laisser aucune partie à découvert.*

13. Grounding or Polarization — Do not defeat the grounding or polarization of the 8•Bus Console and External Power Supply.

This apparatus does not exceed the Class A/Class B (whichever is applicable) limits for radio noise emissions from digital apparatus as set out in the radio interference regulations of the Canadian Department of Communications.

*ATTENTION — Le présent appareil numérique n'émet pas de bruits radioélectriques dépassant les limites applicables aux appareils numériques de class A/de class B (selon le cas) prescrites dans le règlement sur le brouillage radioélectrique édicté par les ministere des communications du Canada.*

14. Exposure to extremely high noise levels may cause permanent hearing loss. Individuals vary considerably in susceptibility to noise-induced hearing loss, but nearly everyone will lose some hearing if exposed to sufficiently intense noise for a period of time. The U.S. Government's Occupational Safety and Health Administration (OSHA) has specified the permissible noise level exposures shown in the following chart.

According to OSHA, any exposure in excess of these permissible limits could result in some hearing loss. To ensure against potentially dangerous exposure to high sound pressure levels, it is recommended that all persons exposed to equipment capable of producing high sound pressure levels use hearing protectors while the equipment is in operation. Ear plugs or protectors in the ear canals or over the ears must be worn when operating the equipment in order to prevent a permanent hearing loss if exposure is in excess of the limits set forth here.

Duration Per Day In Hours	Sound Level dBA, Slow Response	Typical Example
8	90	Duo in small club
6	92	
4	95	Subway Train
3	97	
2	100	Very loud classical music
1.5	102	
1	105	Patrice screaming at Ron about deadlines
0.5	110	
0.25 or less	115	Loudest parts at a rock concert

**WARNING** — To reduce the risk of fire or electric shock, do not expose this appliance to rain or moisture.



## IMPORTANT SENSITIVITY ADJUSTMENT PROCEDURE!

24•8  
32•8  
Owner's  
Manual  
Version  
Rev. A  
06/03

To fully achieve the Mackie 8•Bus console's impressive headroom and specs, you should "tune" channel sensitivity for each channel.

### FOLLOW THIS PROCEDURE FOR EACH CHANNEL IN USE:

1. Assign signal to channel fader:
  - If channel will be used with a microphone, MIC/LINE switch should be *up* & FLIP switch should be *up*.
  - If channel will be used with line input, MIC/LINE switch should be *down* & FLIP switch should be *up*.
  - If channel will be used with a tape input keep the FLIP switch *down*.
2. Set channel strip controls as follows:
  - TRIM pot all the way counterclockwise (+4dB)
  - AUX SEND controls all the way counterclockwise (*off*)
  - EQ switch *up*
  - LOW-CUT switch either *on* or *off* (*on* recommended for mic inputs)
  - Pan hard left or right
  - Channel fader at UNITY
  - SOLO switch *down*
3.  Make appropriate "noise" into the channel input. For example, have a performer play/sing/strike something or someone, etc., at the level at which they're going to record or perform. Don't just play a single sustained note, but rather, jam away as you would be during recording or performance. If the channel is being used for a tape input

during mixdown, roll an already-recorded track from your recorder.

4. The channel's -20dB LED may light. The L/R main meters will show the actual internal operating level of soloed signals. Now you will optimize levels.
5.  For mic or line inputs, adjust the TRIM control clockwise to get peaks that regularly hit 0dB on the L/R meters. For mic inputs this may require full CW rotation depending on the sensitivity of the mic.
6. If desired (optional):
  - Press the EQ switch *in*.
  - Adjust the channel strip's EQ to about what you will be using during the session.
  - Re-perform Step 5.
7.  Return the channel strip's SOLO button to its *up* position.
8.  Repeat Steps 1-7 on the next channel that is being used.



**Please put your serial number here for future reference (i.e., insurance claims, tech support, return authorization, gloating privileges, etc.):**

Serial #



## PLEASE! SAVE THE SHIPPING BOX!

Yes, we know it's only slightly smaller than a doublewide mobile home, but you will need the entire carton and internal foam if your console ever needs service at some time in the future.

If your kids make the box into a fort and cut holes in it — or if you stuff it in the dumpster of the fast-food place next door to your studio, we may have to sell and ship you another packing box later on. Don't end up buying an empty box!

# TABLE OF CONTENTS

## SECTION 2\* —

### Panel Layout and Function.. 4

INPUT CHANNELS .....	4
<i>Fader</i> .....	4
<i>Mute</i> .....	4
<i>Pan &amp; Assignment switches</i> .....	4
<i>-20 &amp; OL LEDs</i> .....	5
<i>Channel Solo</i> .....	5
<i>Phantom power</i> .....	5
<i>Trim</i> .....	5
<i>Mic/Line switch</i> .....	5
<i>The Flip Switch:</i>	
<i>Mic/Line or Tape?</i> .....	6
<i>MIX-B / Monitor</i> .....	6
<i>MIX-B Pan</i> .....	6
<i>MIX-B Level</i> .....	6
<i>MIX-B Split</i> .....	7
<i>EQ Section</i> .....	7
HI Mid EQ .....	7
LO Mid EQ .....	8
HI EQ .....	8
LO EQ .....	8
EQ In/Out .....	8
LO cut .....	8
<i>AUX Sends</i> .....	8
AUX 1 & 2 .....	9
Pre (1&2) .....	9
AUX 3, 4, 5, 6 .....	9
Shift .....	9
Source .....	9
Pre (3-6) .....	9
OUTPUT SECTION .....	10
<i>8•Bus Faders</i> .....	10
<i>L Mix and R Mix</i> .....	10
<i>Mono L &amp; R</i> .....	10
<i>Solo</i> .....	10
<i>L/R Mix Fader</i> .....	10
<i>Metering Bus</i>	
<i>Meters 1-8</i> .....	11
<i>Main/Solo Meters</i> .....	11
<i>AUX Sends</i> .....	11
<i>AUX Solo</i> .....	12
<i>Stereo AUX Returns</i> .....	12
Returns 1 & 2 .....	12
Assign (1&2) .....	12
Returns 3 & 4 .....	12
Assign (3&4) .....	12
Returns 5 & 6 .....	12
MIX-B/Monitor .....	12
Phones .....	13
Monitor .....	13
Solo .....	13
Talkback .....	13
<i>Jack panels (input strip and Master output)</i> .....	14
Input Strip .....	14
Phantom power .....	14
BNC sockets .....	14
Mic In .....	14
Line In .....	14
Direct Out .....	14
Channel Insert .....	14
<i>Output Panel</i> .....	15
Submaster Inserts .....	15
AUX Sends .....	15
AUX Returns .....	15
Main Inserts .....	15
Control Room Output .....	15
Main Mix .....	16

MIX-B Output .....	16
Phones .....	16
Studio Output .....	16
2-Track Input and External Input .....	16
REAR PANEL CONNECTIONS .....	17
<i>Tape Returns</i> .....	17
<i>Tape Return</i>	
<i>Operating Level</i> .....	17
<i>Submaster/Tape Outputs</i> .....	17
<i>Submaster/Tape Output</i>	
<i>Operating Level</i> .....	17
<i>Main Bal. Outputs</i> .....	18
<i>Expander Port</i> .....	18
<i>DC Power in</i> .....	18

## SECTION 3 —

General Information .....	19
LEVELS .....	19
<i>Noise</i> .....	19
<i>Headroom</i> .....	19
<i>Unity Gain</i> .....	19
<i>Metering</i> .....	19
BUSES .....	20
SENDS & RETURNS .....	20
SOLO .....	20
EQ .....	20
CONNECTORS .....	22
A BIT MORE ON MIX-B/FLIP .....	22

## SECTION 4 —

Recording .....	23
RECORDING OVERVIEW ..	23
SETUP .....	23
RECORDING & OVERDUBBING .....	23
<i>Using Buses</i> .....	23
<i>Monitoring</i> .....	23
<i>Cue Mix</i> .....	23
<i>Wet or Dry Monitor?</i> .....	24
<i>Let's Record!</i> .....	27
<i>Overdub, Anyone?</i> .....	27
MIXING OVERVIEW .....	27
MIXING SETUP .....	28
<i>Pick a Model</i> .....	28
<i>Consider Compression</i> ..	28
DOING THE MIX .....	28
<i>Using External Processing</i> ..	28
<i>Insert Devices</i> .....	28
<i>Send / Return Devices</i> ....	35
<i>Using Subgroups</i> .....	35
<i>Finding More Inputs:</i>	
<i>Mix-B to L &amp; R Buses</i> ....	35
<i>Monitoring and Levels</i> ..	36
<i>About Automation</i> .....	36

## SECTION 5:

PA and Sound Reinforcement Applications .....	37
SETUP .....	37
HOUSE AND MONITOR MIX TOGETHER .....	42
<i>Headphones</i> .....	42
MAKING A SIMULTANEOUS RECORDING .....	42
HOUSE MIX ONLY or MONITOR MIX ONLY .....	42
<i>Mic Splitters</i> .....	43
FINDING MORE INPUTS ...	43

## APPENDIX A: Connections .. 44

“XLR” CONNECTORS .....	44
1/4" TRS PHONE PLUGS & JACKS .....	44
1/4" TS PHONE PLUGS & JACKS .....	44
SWITCHED 1/4" PHONE JACKS .....	44
RCA PLUGS & JACKS .....	45
UNBALANCING A LINE .....	45
SPECIAL CONNECTIONS ..	45
<i>TRS Send/Return</i>	
<i>Insert Jacks</i> .....	45
<i>Using the send only of an insert jack</i> .....	45
<i>Using return only</i> .....	46
AUX RETURNS: Mono, Stereo, Whatever .....	46
MULTS AND “Y”s .....	46

## APPENDIX B: Options, Add-Ons and Extra Stuff .....

METER BRIDGE .....	47
SIDECAR .....	47
UN-CIGARETTE LIGHTER ..	47
MIXING SHOES .....	47

## APPENDIX C: Specifications .. 48

GAIN/LEVEL CHART .....	48
DIMENSIONS .....	49
BLOCK DIAGRAM .....	52

## SERVICE .....

TROUBLESHOOTING .....	54
FACTORY SERVICE .....	54
SERVICE FROM AN AUTHORIZED SERVICE CENTER .....	55

## TRACK SHEET .....

## 8•BUS LIMITED WARRANTY 61

\* Why did we start with Section 2? As a matter of policy, our Manual Table of Contents always skip things that are on the facing page to the actual listing. Seems like we're stating the obvious to tell you that the Introduction is next to your right hand.

# SECTION 1: Introduction

The Mackie 8•Bus Series is a flexible ‘in-line monitoring’ style console. They are available with 24 or 32 microphone/line inputs fed into 8 submix buses, 2 stereo mix buses and 6 auxiliary send buses. There are 24 or 32 tape return inputs for multitrack monitoring and mixing or for use as additional line inputs. The 8•Bus Series is designed to be the mixing and communications hub in a multitrack recording studio and is also an excellent choice for sound reinforcement work. Numerous inputs, flexible sends and terrific EQ combined with the legendary Mackie headroom and noise floor specs make your work easy. It’s clean. It’s quiet. It’s packed with features. It’s affordable. . . So pat yourself on the back! You’re doing something sensible here!

## IF YOU IGNORE MANUALS...

You’ll probably ignore this one, too. That’s OK, the crack Mackie Documentation Department will get to go on their annual “*Typing Without Walls*” outing at campsite four in the Woodinville RV Park anyway.

But this is a really great manual! It’s got Where It Is and What It Does and How To Use It covered totally, with pictures and diagrams and absolutely no pop quizzes.

Do yourself a favor and at least check out Section 2 and the block diagram for starters. The 8•Bus Series has a number of routing tricks that could be hard to suss out without a guide. Then, if that’s all you can take without pumping some sound through the console, put the manual in the bathroom for future reference or read it while you eat your lunch.

If you’re even more terminally impatient, try to look for these two icons:

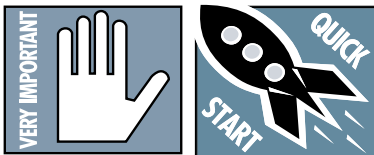

They cover information that is absolutely critical or is unique to the 8•Bus Series. At some point, it’s still a good idea to browse through the rest of the manual.



In addition, sections marked with the A CLOSER LOOK icon include in-depth information. . . or at least our own opinions.



PANEL LAYOUT AND FUNCTION

LAYOUT AND FUNCTION

GENERAL INFORMATION

GENERAL INFO



RECORDING

RECORDING



PA AND SOUND REINFORCEMENT

PA & SR

APPENDICES  
(CONNECTIONS, ADD-ONS, SPECIFICATIONS, ETC.)

ADD-ONS  
SPECS  
ETC.

SERVICE

SERVICE

MASTER TRACK SHEETS FOR DUPLICATION

TRACK SHEETS

BLOCK DIAGRAM

BLOCK DIAGRAM

# SECTION 2: Panel Layout and Function

## OVERVIEW

The panel layout of the Mackie 8•Bus Series follows the traditional arrangement: input channel strips to the left, with a master output/monitoring/cue section to the right. Additionally, most of the Mackie input/output jack panel is located at the top of the mixing panel, for easy accessibility and patching. The tape outputs and inputs are on the rear panel.

## INPUT CHANNELS (CHANNEL STRIPS)

The 24 or 32 input channel strips on the Mackie 8•Bus consoles are identical, and contain all of the level, assignment and equalization controls for each input channel. This section describes the controls and functions of each feature of an input channel in detail.

## FADER

The channel fader (1) is 100 millimeters long, with a precise logarithmic taper and attenuation in dBs printed along the slot for exact and repeatable level adjustments. The fader affects either the mic or line input to the channel (for recording) or the tape return to the channel (for mixing), depending on the position of the FLIP switch.

## MUTE

The MUTE switch, located at the top of the fader (2), turns off the primary outputs of the channel: the eight buses, the L & R buses, the channel solo, the direct output and the post-fader AUX sends. Pre-fader aux sends are not muted. With the exception of lighting the mute LED, pushing the MUTE switch is the same as pulling the fader all the way down.

## GOURMET PAN CONTROL AND ASSIGNMENT SWITCHES

The PAN control (3), immediately above the fader, pans the channel signal between the two sides of the L/R Mix buses, and also between odd and even pairs of buses 1 through 8.

The actual bus assignment of the PAN control depends on the positions of the five assignment switches located along the length of the fader. With no switches depressed, the PAN control has no effect (well, unless you solo the channel; it still pans the solo).

Pushing the L/R MIX switch (4) assigns the PAN to the main L/R Mix buses. Panning from L to R moves the sound smoothly (with constant loudness) from the left channel to the right channel. Assigning the PAN to a pair of the 8 buses has a similar effect. For example, pushing the 1-2 switch assigns the PAN to buses 1 and 2, and panning L to R will move the sound from bus 1 to bus 2 (from odd to even).

If you want to equally assign a channel to both buses 1 and 2, leave the PAN control at the top, or center, of its travel. If you only want bus 2, turn the PAN control fully clockwise (to the right).

Other comparably-priced consoles provide as little as 50dB attenuation/separation. We use active, buffered circuitry and a custom-taper potentiometer

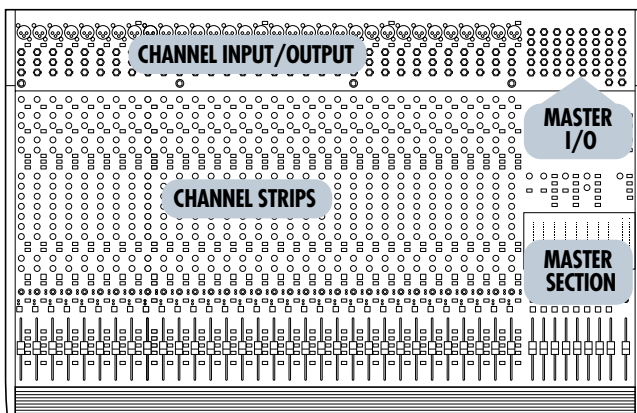
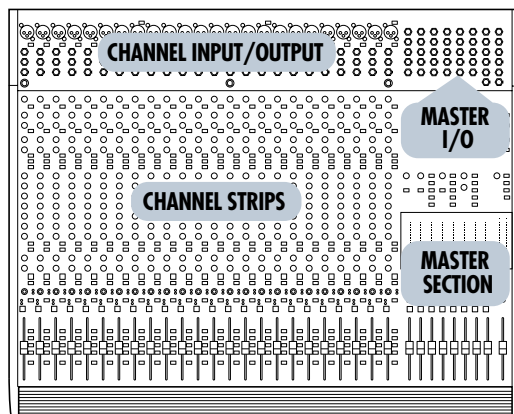
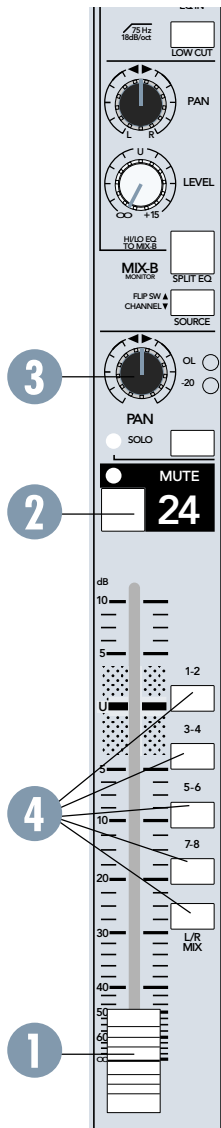

to achieve 87dB attenuation. You get far better channel separation plus freedom from level shifts caused by channel assignment and panning. In addition, our pan pots are *constant loudness*. When you sit between a pair of monitors and pan from side to side, the apparent volume at your ears should stay the same, no matter where the signal is positioned. Our special pan circuitry maintains consistent apparent energy whether the pot is dead center, hard left or hard right.

## -20 AND OL LEDs

The two LEDs (5) next to the PAN control check the channel strip signal level at three important circuit points: at the output of the mic/line preamp, after the EQ and after the channel fader amplifier.

The green LED marked -20 is there to assure you that, yes, something is plugged into the channel (and yes, it does have some output). Most signals more interesting than tape noise will cause the green LEDs to flicker, so they give you a good visual indication of which channels are active. Any peaks higher than -20dBu (@ 1kHz) trigger the indicator. When we say “channel”, we mean the signal going through the channel fader. . . but not the signal going through the MIX B Section. Please refer to the MIX B section of this manual, starting on the next page, for more details.

The red LED, labeled OL for overload, lights when the signal level is high enough to cause clipping at any of the three test points. In normal operation it will almost never light. If it is flashing at you, your level in that channel is much too high. You need to turn something down.

- First try the mic/line trim. If that has no effect,
- Turn down the EQ and/or the insert device, and if that doesn't fix it,
- Turn down the channel. If this doesn't fix it, your input signal is too hot (gasp). Use an external pad to reduce the level (see the sidebar on page 24).

## CHANNEL SOLO

The channel SOLO switch (6) assigns the output of the channel PAN control to the stereo solo buses and disconnects all other sources from the monitor section. SOLO does not interrupt the eight Submasters, the L/R Mix or the AUX sends, and can be used at any time without affecting the recording process.

SOLO is handy for spot-checking the presence and quality of individual inputs while setting up, recording and mixing. More than one SOLO switch may be pressed at the same time, allowing you to listen to the blend of any combination of channels throughout the console in stereo.

On the Mackie 8•Bus console, the SOLO assignments are stereo except for the AUX sends. SOLO maintains the perspective set up with the PAN controls. When any SOLO button on the console is depressed, its associated SOLO LED will glow steadily, and the RUDE SOLO LITE above the 8•Bus LED meters blinks annoyingly, serving as a reminder with an attitude.

The channel SOLO function is normally post-fader/post-mute, but can be modified for PFL or Pre-Fade (and pre-mute) Listen. See Appendix B: Options, Add-Ons, and Extra Stuff.

**Note:** All the SOLO buttons on the 8•Bus Series operate in the same way (although they're not all stereo like the channel SOLO). SOLO does not interrupt recording; it only affects the control room monitor.



**HIGHLY, MEGA-MONDO-IMPORTANT:** SOLO is intended for more than just “soloing.” It is THE way to set levels for best noise and headroom. Complete instructions on proper level setting using SOLO are in Section 3: General Information, starting on page 19.

## PHANTOM POWER

**CAUTION:** After switching PHANTOM Power on or off, wait 1 minute before changing any mic/line switch settings in that 8-channel block.

At the top of every eight channels is a PHANTOM Power switch (7). Pressing it sends +48VDC to the eight XLR sockets to the switch's left. For instance, depressing the PHANTOM switch above Channel 8 sends phantom power to the XLRs on channels 1 through 8. **NOTE:** It is always a good idea to check with the Mic manufacturer to verify phantom power requirements.

## TRIM

The TRIM control (8) sets the gain of the input amplifier for the MIC and LINE inputs. Proper setting of the TRIM control is essential for good noise and headroom performance. Trim pot settings may vary widely depending upon the input level. The output of different keyboards, drum machines, guitar effects boxes, etc., vary from extremely weak to so hot that they can practically be connected directly to speakers. See pages 1, 19, or 24 for advice.

## MIC/LINE SWITCH

Now we've jumped back to the top of the strip. Sorry, but logically the input to the channel is the next thing to talk about. That's because it's the source of the signal applied to the channel fader and PAN control.

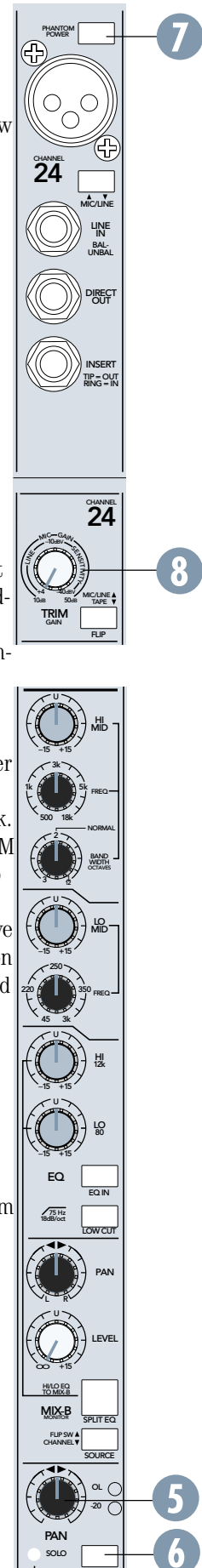

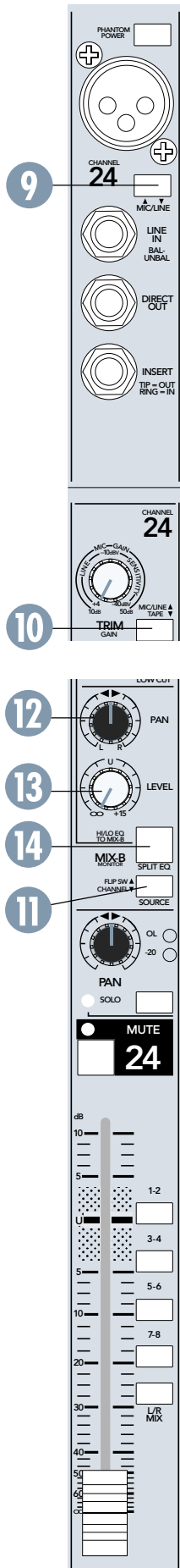

The MIC/LINE switch (9) is located way up amongst the channel jacks. It selects whether the MIC jack (pin 2=hot[+], pin 3=cold[-], pin 1=shield) or the LINE jack (balanced 1/4" phone... tip=hot, ring=cold, sleeve=shield) is connected to the input amplifier.

### THE FLIP SWITCH: MIC/LINE OR TAPE



The switch labeled FLIP (10) selects the input that is actually fed into the channel fader (and the MIX-B control; see below). As the label indicates, the MIC/LINE input (after Mic/Line preamp) is fed to the channel fader when the FLIP switch is in the *up* position. This is the normal mode for tracking and overdubbing. In the *down* position, the TAPE return (the output signal from the corresponding track of your recorder) is fed to the channel fader. This is the normal position for mixdown.

To recap - when the FLIP is *up*, the Mic/Line feeds channel and Tape return feeds MIX-B. When the FLIP is *down*, the channel is Tape and MIX-B is MIC/LINE. FLIP.. FLOP. OK?

For live PA, leave the FLIP switch *up*.

### MIX-B / MONITOR



Each channel strip has a dual signal path (Enter Mix-B!) with extremely flexible switching. This allows either the mic/line inputs or tape return inputs to be routed through either the channel fader path or Mix-B with separate EQ and monitoring. Both of the signal paths can be combined into the main mix by depressing the Mix-B to L/R Switch in the master section. OK, now we jump down the channel again to the MIX-B/Monitor section. This handy and very simple feature is also called "in-line monitoring" and is found on quite a few consoles. So we're not claiming that it's anything new... we just added some extra features for more flexibility. MIX-B/Monitor routing options can get a bit complicated, so pay attention. Also, we did add something that other in-line monitoring systems don't have. So double pay attention.

The MIX-B buses are a stereo pair, independent of the 8-plus-2 recording buses we've talked about so far. There are three sources available to MIX-B: MIC/LINE or TAPE (via the FLIP switch) and the pre-fader output of the channel strip (via the SOURCE switch). A fourth source, post-fader output of the channel

strip (via the source switch), can be achieved by modifying the channels. Instructions for this modification can be found on our website at [www.mackie.com](http://www.mackie.com) (click on Support). Or you can call Tech Support at 1-800-258-6883 for assistance.

1. When the Mix-B SOURCE switch (11) is *up*, MIX-B receives its input from the FLIP switch. Remember, the FLIP switch alternates MIC/LINE or TAPE to the channel strip and to MIX-B. With TAPE as an input (SOURCE *up* to select the FLIP switch, and FLIP in the *up* position), the MIX-B section functions as a tape monitor submix, allowing you to listen to the inputs and outputs of your multi-track recorder as you record. This is the most common use of the MIX-B section, during tracking and overdubbing.
2. With MIC/LINE as an input (SOURCE *up* to select the FLIP switch, and FLIP in the *down* position), MIX-B becomes an additional input to add tracks or effects during a mixdown. Simply plug the additional signal into the MIC or LINE connector. Although they are normally separate, a button (MIX-B TO L/R MIX) in the Output Panel (see below) can add the output of the MIX-B buses to the L/R Mix buses. Voilà! Double your mix inputs!
3. With CHANNEL as an input (SOURCE *down* in CHANNEL position), MIX-B taps its signal from the channel strip, just before the channel fader. MIX-B is separately pan-able, EQ-able and can be used as an alternative stereo mix, a stereo auxiliary send, a quadrasonic or surround feed, you name it. Mix B can also have its own aux send (see Aux sends 3-6).

Check out Section 3: General Info and the Block Diagram for more information on MIX-B routing.

### MIX-B PAN

The PAN control (12) routes the channel's MIX-B signal across the left and right MIX-B buses.

### MIX-B LEVEL

The LEVEL control (13) sets the level of the channel sent to the MIX-B buses. The gain structure of this circuit (like the AUX send 1-6 circuits, below) includes extra amplification. What this means to you is that you will always have plenty of gonadotropic gain available for the MIX-B buses. Full left on the LEVEL control is *off*; the midpoint of travel is "U", or unity gain; full right is 15dB of boost.



## MIX-B SPLIT

The SPLIT switch (14) in the MIX-B section splits the EQ section of the channel when depressed. In the *up* position, all four sections of EQ remain, if engaged, in the primary channel signal path feeding the channel fader and the 8-plus-2 buses. In this mode there is no equalization in the MIX-B path.

When the SPLIT switch is depressed, the HI and LO shelving sections of the EQ are removed from the channel signal and inserted into the MIX-B signal path. The HI-MID and LO-MID parametric sections of the EQ remain, if engaged, in the channel signal path.

The SPLIT function allows you to EQ the channel's signal and its MIX-B signal separately.

**Note:** When the EQ is split, the main EQ IN/OUT switch only switches the channel signal's parametric sections. It does not affect the shelving sections split to MIX-B.

## EQ SECTION

Each 8•Bus channel strip equalizer section has four bands (HI MID, LO MID, LO, and HI) plus a low-cut filter. The equalizer can be split between main channel signal and MIX-B signal.

### HI MID EQ

The HI MID EQ section (15) is a true 3-control parametric design, offering: **A)** bandwidth variable from 3 octaves to 1/12 octave (16); **B)**  $\pm 15$ dB of equalization (17) and **C)** variable frequency center from 500Hz to 18kHz (18).

We spent a lot of time on this part of the 8•Bus Series' EQ. One of the things we've always noticed about lower-priced consoles was how "drastic" their Hi Mid EQ sounded. Even a little boost could induce honkiness and nasality. Frankly, Hi Mid EQ on many boards is not that useful in studio applications for just this reason.

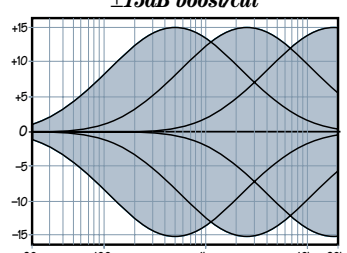
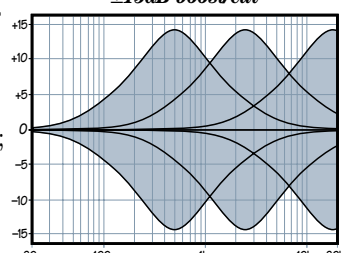
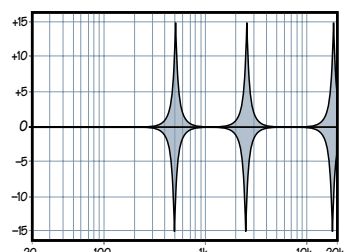
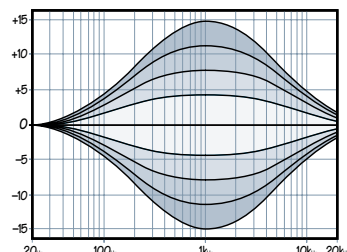
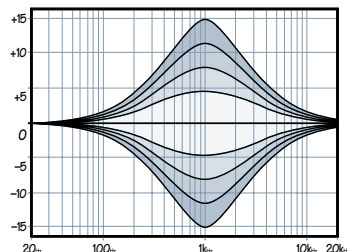
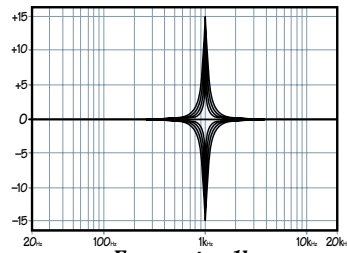

When you put these consoles on the test bench, you see that the bandwidth of their EQ is simply too narrow — often around one octave. This is OK for extreme adjustments in live situations, but that's about it. It's just not wide enough to gently alter the multiple octaves that voices and instruments span.



This is just the opposite of "classic" big-studio consoles.

Their EQ (including Hi Mid) can be adjusted to be extremely broad — three or more octaves wide in many cases. When you apply this wideband EQ, it sounds far more "sweet" and "natural." Changes sound so gradual and smooth that you can add considerably more EQ than would ever be possible with narrower-band consoles, yet without compromising the overall sound.

On the other hand, ultra-narrow-band EQ also has its place, both as a corrective tool and for special effects. So why not give you even tighter control than would be possible with a 1/3-octave graphic equalizer? Thus was born the 8•Bus' 1/12-octave to 3-octave width range.

At this point, as we played around with the Bandwidth and Boost/Cut controls using actual music, we realized that to limit this circuit to *just* Hi Mid (typically above 2.5kHz) would actually limit its usefulness. The flexibility that true parametric control provides is nice to have in the octaves below the Hi Mid region as well. So we came up with what is probably the first console Hi Mid control that can be swept all the way down to 500Hz. If Hi Mid doesn't do it for you as a name, think of these three controls as the Roving-Parametric-Problem-Solver-O-Matic. O-Rama.

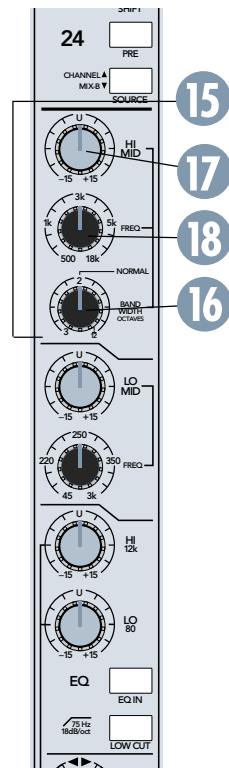

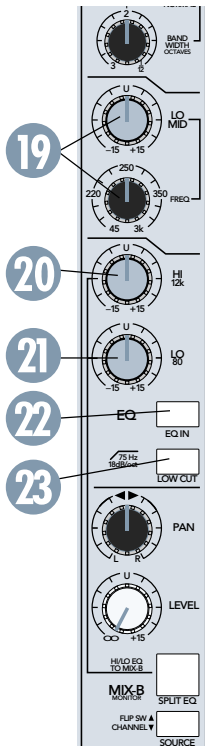

Now you know some of the design philosophy behind our Hi Mid EQ. It's time to start experimenting with it yourself. Don't forget to try the control at its bandwidth extremes — especially at the 3-octave end. You'll be pleasantly surprised.

Conversely, if you hate technology and yearn for the sound of that old board you sold to buy an 8•Bus, you can achieve a semi-parametric sound by leaving the BANDWIDTH knob in the middle at 2 octaves.

### LO MID EQ

The LO MID EQ control (19) is a semi-parametric (sweepable) equalizer with a broad, fixed bandwidth of 2 octaves,  $\pm 15\text{dB}$  of equalization and frequency variable from 45Hz to 3kHz.

Boosting in this range can put warmth and body into vocals and instruments. Cutting can really help the clarity of some sounds by reducing boxy and boomy tones.

### HI EQ

The HI EQ control (20) is a fixed 12kHz shelving equalizer with  $\pm 15\text{dB}$  of equalization available. A great treble control, it is switched with LO EQ into the MIX-B circuit if the SPLIT button is depressed.

Shelving equalizers work on a very broad range of frequencies, and consequently, are very musical. In a 12kHz shelf like this section, that means that all the upper harmonics of a sound are raised evenly, basically keeping their original musical relationship to each other. A high-frequency shelving EQ is great for putting shimmer into acoustic guitar and piano tracks and sizzle into vocals.

### LO EQ

The LO EQ control (21) is a fixed 80Hz shelving equalizer with  $\pm 15\text{dB}$  of equalization avail-

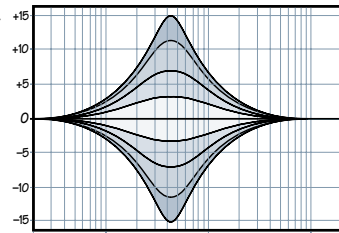

**Lo Mid EQ**  
2 octave  $\pm 15\text{dB}$  boost/cut

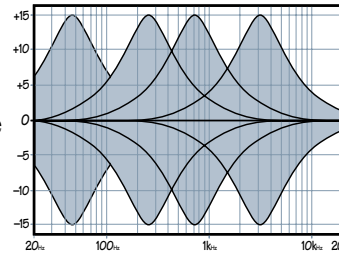

**Lo Mid EQ sweeps**  
from 45Hz to 3kHz

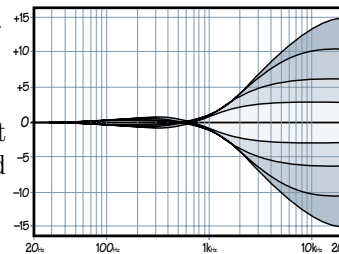

**Hi EQ  $\pm 15\text{dB}$  boost/cut**  
above 12kHz

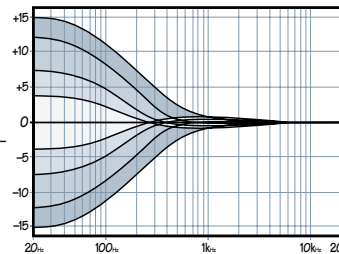

**Lo EQ  $\pm 15\text{dB}$  boost/cut**  
below 80Hz

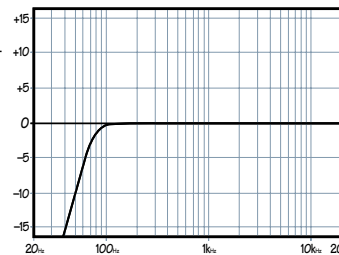

**Lo cut (high pass filter)**  
18dB/oct. at 75Hz

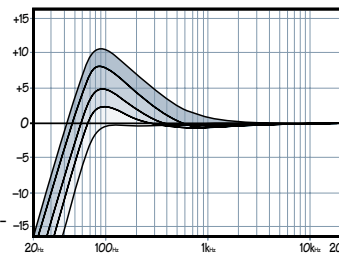

**Interaction of Lo Cut**  
with Lo EQ boost.  
*Verry centersteeng, no?*

able. It's a fine bass control, and is switched with HI EQ into the MIX-B circuit if the SPLIT button is depressed.

A low-frequency shelving equalizer will add or remove bass in a smooth, musical fashion. Good for working on bass drum and bass guitar, fattening up (or thinning out) a piano or contouring an entire mix.

### EQ IN/OUT

The IN switch (22) bypasses the EQ (though not the LO CUT filter) when *up*. Depress it to enable equalization.

### LO CUT

The LO CUT switch (23) inserts an 18dB/octave low-cut (high-pass) filter with a  $-3\text{dB}$  point of 75Hz into the main channel signal. The LO CUT filter is unaffected by the EQ IN switch.

A low-cut filter is handy to get rid of room rumble, traffic noise, wind noise, popping, and other unwanted very-low-frequency sounds. It can also be combined with LO EQ boosts to produce some interesting bass curves as shown in the last EQ graph on this page. *It is highly recommended that this switch be engaged for vocal microphones, especially in a live P. A. situation.*

### AUX SENDS

Auxiliary sends are generally used to provide mixes for headphone cueing and for effects sends, and in Sound Reinforcement use, can be assigned monitor submix duties. The 8•Bus Series consoles provide 6 mono auxiliary sends with several routing options.

**Note:** All of the 8•Bus Series AUX sends have a very wide range of gain (just like the MIX-B Level control discussed earlier). The first half of the control's rotation reaches from the *off* position to unity gain (U). This half of the control's range corresponds to the full range of a conventional mixer. The second half of the control's rotation provides you with even more gain, from unity to  $+15\text{dB}$ .

For example, when you want a super “wet” sound (mostly reverb), the extra gain allows you to bring the channel fader part way *down* (and the AUX send way up) so the sound is mostly reverb with just a touch of “dry” signal.

Don’t worry about having mono effects sends: almost all effects units, mono or stereo, have mono inputs. Even if there are two jacks labeled Left and Right, they are almost always combined into mono internally. In the rare cases when an effect actually has true stereo inputs, it is often more convenient to ignore that and treat it as mono anyway. If you really need to send in stereo, just use two AUX sends from the console. Route AUX 1, for example, to the left input and AUX 2 to the right. Then adjust the stereo perspective by favoring one or the other send. For instance, if you have a stereo synth into channels 23 and 24, use AUX 1 on channel 23 and AUX 2 on channel 24.

**Note:** In PRE mode, all AUX SENDS are connected pre-fader but post-EQ. This is usually the most useful setup, but if you prefer, all AUX SENDS can be modified to be pre-EQ, pre-fader. Instructions for this modification can be found on our website at [www.mackie.com](http://www.mackie.com) (click on Support). Or you can call Tech Support at 1-800-258-6883 for assistance.

### AUX 1 & 2

Auxiliary sends 1 & 2 (24) have two independent level controls and share a common PRE/POST switch.

When in the normal post mode, sends 1 & 2 get their signal after the channel fader and the MUTE switch. This is the usual configuration for an effects send, since the level of the effect should follow the volume adjustments made by the channel fader.

### PRE (1&2)

With the PRE switch (25) depressed, AUX SENDS 1 & 2 receive their input from a point before the channel fader and MUTE switch, and are not affected by changes in these controls. This is the normal switch setting for creating stage monitor and/or studio cue headphone sends.

### AUX 3, 4, 5, 6

Auxiliary sends 3, 4, 5, and 6 (26) are very similar to sends 1 & 2. The differences are in the SHIFT and SOURCE switches. Read on.

#### SHIFT

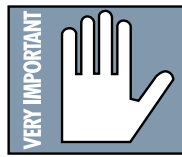

The SHIFT button (27) connects the two level controls, as a pair, to either sends 3 & 4 (in the up position) or to sends 5 & 6 (in the down position). Twice the sends in half the space.

#### SOURCE

The SOURCE switch (28) breaks AUX Sends 3-6 away from the main channel strip world that sends 1 & 2 are stuck in, and allows the sends to tap from another source: the MIX-B signal for that channel. This is a very handy thing, whatever you happen to be using MIX-B for.

If MIX-B is an additional input for your mix-down, then (when the SOURCE switch is depressed) AUX Sends 3-6 are effects sends connected to that source. If MIX-B is your studio monitor submix from the recorder, then AUX Sends 3-6 are a great source of headphone cue signals. They will follow playback, record and punch-ins automatically as your recorder does its stuff.

### PRE (3-6)

The PRE switch (29) for Sends 3-4-5-6 functions just like the PRE switch sends 1 & 2, when the AUX SOURCE switch is in the CHANNEL (*up*) position.

Additionally, the PRE switch will tap the pre-level (and pre-mute) signal of whichever SOURCE you have selected-channel or MIX B.

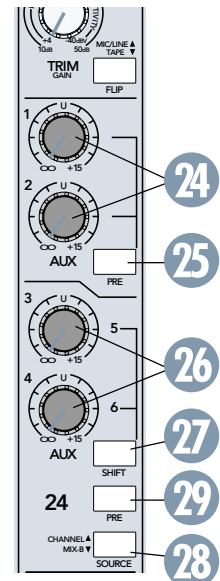

LAYOUT AND FUNCTION

## OUTPUT SECTION

The output section is the large area to the right of the input channel strips. It contains the master faders and metering, as well as the send and return masters, cue, monitoring and communication controls.

### 8-BUS FADERS

At the bottom of the output panel are the master faders for each of the eight buses (1). Each fader controls the level of its mix, with precise dB markings and a unity gain point marked on the panel. The fader is located in the circuit after the submaster insert jack but before the final line amplifier.

There is an Assign section associated with each bus fader, detailed below. Note that no matter what the selection of the assignment switches, the output of each bus is always present at its Submaster/Tape Output jack and is monitored on its own bus meter.

### L MIX and R MIX

The odd-numbered buses have an L MIX button above their faders (2); the even buses have an R-MIX button (3). Pressing this button assigns the bus to the L or R Mix bus, respectively. This switch, along with the MONO L & R switch dis-

ussed below, allows you to assign submix buses within your L/R mix.

### MONO L & R

The MONO L & R switch (4) functions ONLY when you have first depressed the L MIX or R MIX. If you've pushed L MIX or R MIX, pushing MONO L & R will assign the bus to both channels of the Left and Right Mix buses, instead of just the Left, or just the Right. This is also for submixing, but allows you to put your submix in the center rather than on either side.

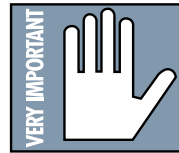

(Those of you with patch cords have probably realized you can patch the bus into a channel and do even more fun things, but we'll talk about that later.)

### SOLO

The SOLO button (5) solos the output of the bus fader. When any SOLO button is pressed, the SOLO LED lights.

This is a pretty trick SOLO, too. If you have not pushed the MONO L & R switch, the SOLO sends the odd-numbered tracks to the left speaker and the even-numbered tracks to the right, whether or not the associated L MIX or R MIX is engaged. But if you

have pressed MONO L & R, the SOLO circuit is smart enough to send the bus to both speakers and put the stereo image in the middle. You will be the envy of your neighborhood.

### L/R MIX FADER

The L/R MIX fader (6) is a stereo fader located at the far right of the console. The fader controls the level of the L/R MIX bus, with precise dB markings and a unity gain point marked on the panel. This fader, like the bus faders, is located in the circuit after the L/R insert jack but before the final line amplifier.

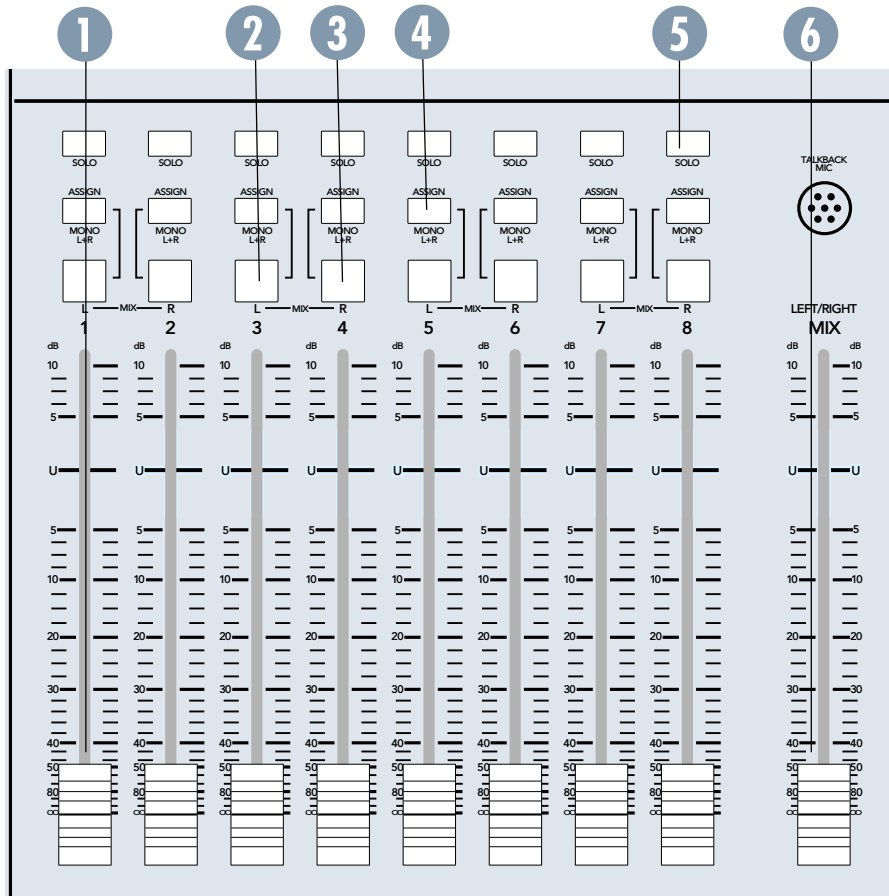

## METERING

### Bus Meters 1-8

Directly above each bus fader is a peak-reading meter displaying the bus output level. Zero (0) on the meter references a level of +4dBu (1.23 volts RMS) at the output jack.

**Note:** If the -10dBV switches are engaged at the Subgroup output jacks, then zero (0) on the meter references a level of -10dBV at those outputs.

**Note:** When any SOLO switch is engaged, the SUBMASTER meters will be extinguished in order to divert your attention to the SOLO/MAIN meters (discussed below).

### MAIN OR SOLO LEVEL Meters

The MAIN OR SOLO LEVEL meters display the L/R Main Mix levels and are similar to the bus meters, with these exceptions:

- If a SOLO button is depressed, the meters display the output of the soloed signals; if not, the meters show the level of the signal selected by the MONITOR SOURCE switches. In other words, you are always metering what you're listening to.



#### IMPORTANT:

When the console is in SOLO mode, zero (0) on the SOLO/MAIN

meters references the actual internal operating level, or 0dBu (.775v). If you have just one signal in the main L/R path and you SOLO it, the meter level will jump up 4dB. Don't be alarmed. If you're mixing on the L/R buses, that's what you'll meter. If you're checking a tape playback, that's what you'll meter. When the meters are following the monitors (not in SOLO), zero (0) on the meter references a level of +4dBu (1.23 volts RMS) at the main L/R outputs, just like the submaster meters.

**Note:** The solo levels displayed on the meters are PRE-solo level, thus giving you an accurate showing of the total level of the soloed signals. This is also the way to set initial console levels. See the discussion of the SOLO function, earlier in this section.

- Additional red LEDs per side at the top of the meter show output clipping at +28dBu balanced,

+22dBu unbalanced. (You don't want these to *ever* go on. If they do, try pulling down the L/R master fader a little.)

## AUX SENDS

The six auxiliary send outputs each have a master level control. Like any level control, turning the knob turns the volume up or down. However, the gain of the AUX Sends has been optimized at the unity (center detent) setting and should not need adjustment.

The output of each bus is available at its AUX Send Out jack in the jack panel above. Additionally, AUX Sends 3 & 4 and AUX Sends 5 & 6 are fed as stereo pairs to the two PHONES SOURCE switching matrices, for headphone cueing purposes.

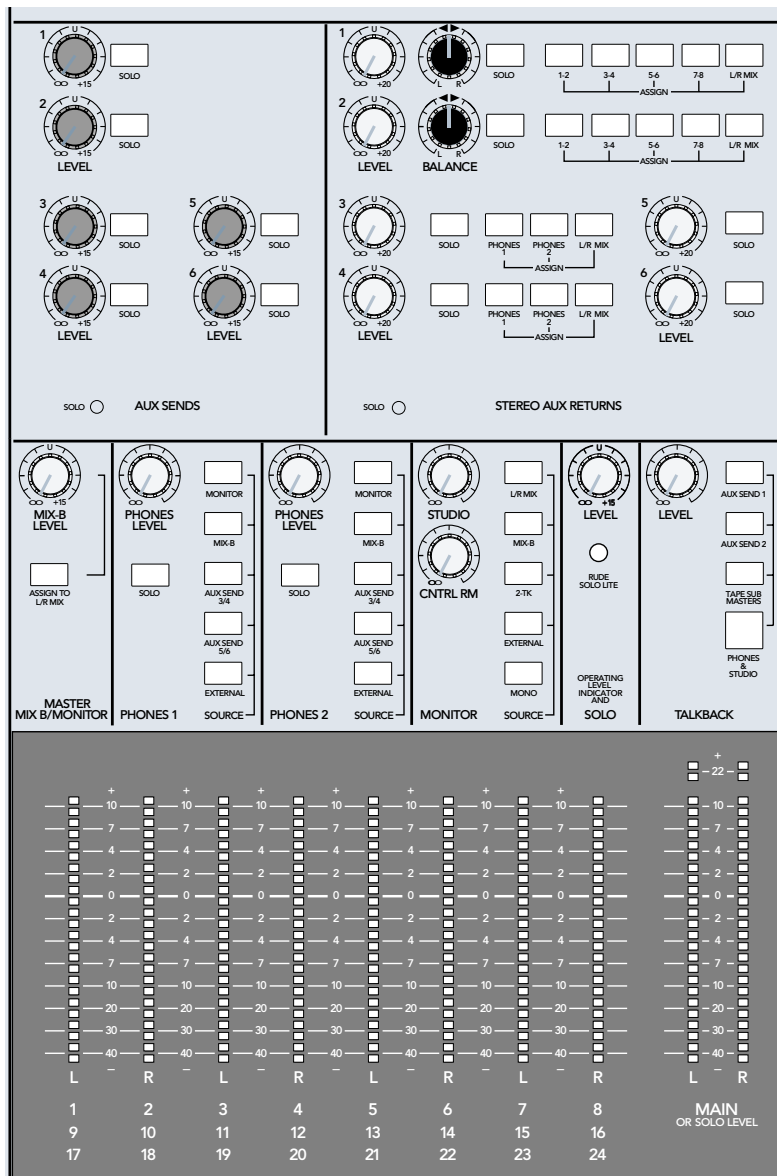

LAYOUT AND FUNCTION

### AUX SOLO

The SOLO button next to each level control (7) solos that send and allows you to check the send level in the main meters. There is a solo LED (8) in the Send section, to help you locate what the heck you soloed.

**Note:** The six AUX Sends are each mono signals, and they are soloed in mono. If you are using a stereo pair of sends for headphone cue, use the SOLO button in the PHONES 1 or 2 areas to check the sends in stereo.

### STEREO AUX RETURNS

The AUX Returns (9) provide 12 additional *inputs* to the console for return from effects and reverb devices. The returns have switch matrices to allow easy assignment to headphones or mix buses. When any return is soloed, the solo LED in the lower left-hand corner of the Return area lights.

For extra flexibility, the AUX Returns have been designed with an extremely wide range of available gain, offering as much as 15dB boost over unity.

The return jacks are wired to provide both stereo and mono operation. See AUX Returns under JACK PANEL later in this section for details.

### Returns 1 & 2

AUX Returns 1 & 2 (10) each have a stereo SOLO switch, a stereo LEVEL control, a BALANCE control and a bank of ASSIGN switches.

### ASSIGN (1 & 2)

AUX Returns 1 & 2 are assigned in stereo pairs (Return 1, L & R; Return 2, L & R) to the L/R MIX buses or to odd-even pairs of the 8 submix buses (11). If you would like an effects return to accompany its dry signal on the multitrack (wet tracks), these are the returns to use.

### Returns 3 & 4

AUX Returns 3 & 4 (12) each have a stereo SOLO switch, a stereo LEVEL control and a smaller bank of ASSIGN switches.

### ASSIGN (3 & 4)

Returns 3 & 4 are assigned in stereo pairs (Return 3, L & R; Return 4, L & R) to the L/R MIX buses or to the PHONES 1 and PHONES 2 buses via respective banks of buttons for each return (13). If you want additional effects returns preset in the headphone mixes, these are the returns to use.

### Returns 5 & 6

AUX Returns 5 & 6 (14) each have a stereo SOLO switch and a stereo LEVEL control. Returns 5 & 6 are permanently assigned to the L/R MIX bus. All returns are useful in a mix-down situation, as they are all assignable to the L/R mix.

### MIX-B / MONITOR

The MIX-B / MONITOR section (15) is quite straightforward. It offers a stereo level control for the MIX-B output, and an ASSIGN: MIX-B TO L/R MIX switch, which can add the MIX-B bus signal to the main L/R Mix. This essentially doubles the inputs available for mixdown. Avoid this pitfall: If you are monitoring the L/R mix in the control room and have the MIX-B to the L/R mix assigned, do not also select MIX-B in the monitor source switch matrix. If you do, MIX-B will sound twice as loud in the control room as it is in the L/R mix!

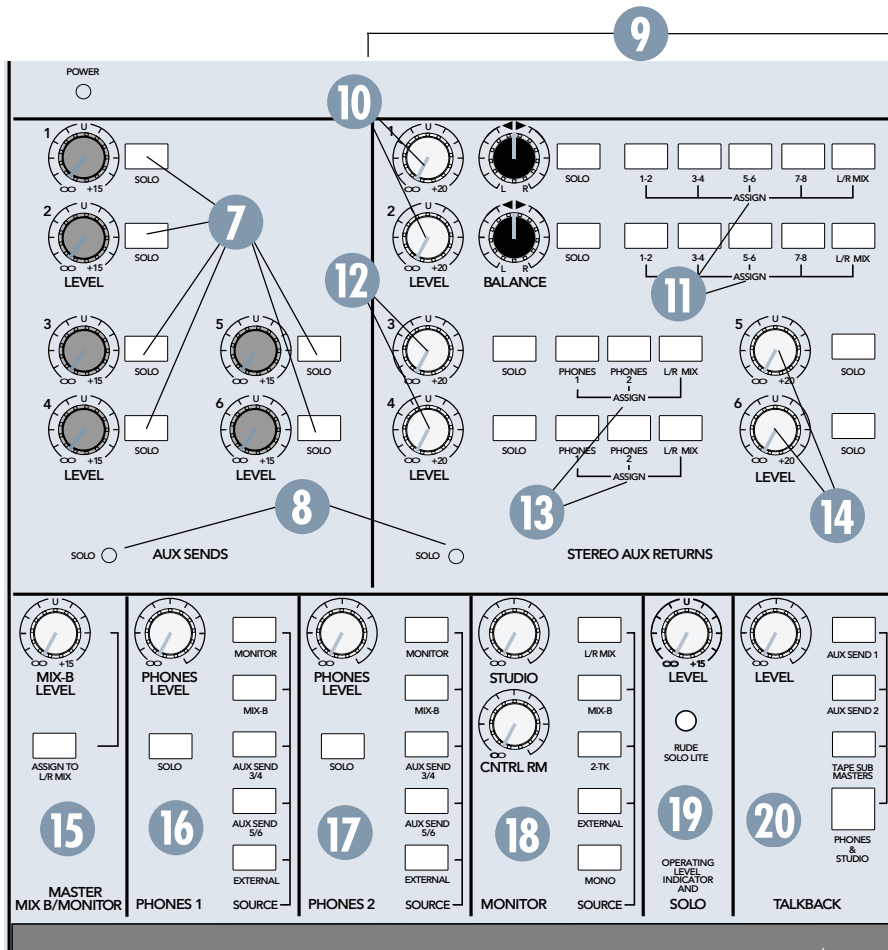

## PHONES

The PHONES 1 (16) and PHONES 2 (17) sections are identical. Each contains a stereo level control for the headphones outputs, a stereo SOLO switch, and five pushbuttons to select from the following signal sources: MONITOR, MIX-B, AUX SENDS 3 & 4, AUX SENDS 5 & 6, and EXTERNAL.



You can select any combination of sources.

- The MIX-B, AUX SENDS 3 & 4 and AUX SENDS 5 & 6 switches are connected directly from the outputs of their respective circuits.
- MONITOR takes the signal from after the MONITOR selection switches described below, and therefore carries the same signal that is applied to the control room monitors. (The PHONES section is not affected by the CNTL RM level control or the MONO switch in the MONITOR section, though.)
- The EXTERNAL switch is connected directly from the L and R EXTERNAL INPUTS in the jack panel above. External is an independent cue channel for click tracks, etc. Its signal DOES NOT appear at any of the channels or buses.

**Note:** If MONITOR is selected as a PHONES source and the solo button in the PHONES section is depressed, nothing will happen except that the Solo LEDs will light up. That's because Solo is disabled under these conditions to prevent a feedback loop and its associated anguish.

**Note:** If nothing is selected, signal may still feed the PHONES from AUX Return 3 & 4, via that section's ASSIGN TO PHONES switches.

## MONITOR

The control room monitors and the studio playback monitors are both controlled from the MONITOR section of the console (18). There is a stereo level control for the control room and another for the studio.

**Note:** Fully clockwise equals unity gain.

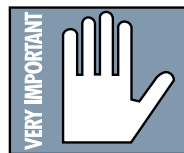

A bank of switches selects the stereo sources available to the speakers from L/R Mix, MIX-B, Tape and External. You can select any combination of signal sources.

The L/R MIX and MIX-B switches are connected from the outputs of the L/R and MIX-B buses. The TAPE and EXTERNAL switches are connected from the 2-TRACK INPUTS and the EXTERNAL INPUTS, respectively, on the jack panel above.

The MONO switch sums the left and right channels together to allow you to check your mix in monaural. This affects only the control room monitor speakers, the studio monitor speakers, and the L/R meters (although the meters are not monoed in solo mode.)

## SOLO

The Solo section (19) contains the master level control for the stereo Solo mix. Set at the center detent, it will match the level of the soloed signals to the same signals unsoloed. This section also has the most obnoxious solo light allowed under international trade and safety regulations. We hope it gets your attention. The monitor switch in the phones section must be pushed in (selected) or the solo bus will not feed the phones. (By the way, if your console has two little tiny Death's Heads above your RUDE SOLO LITE, you are very lucky. Only one in 10,000 Mackie consoles has what we call "Grim Greg" on it, and if you send in the top panel of your console with proof of purchase, we will ship postpaid to your door the bivalve pride of the Northwest, a Quilcene-smoked Geoduck filet, with our compliments!)

## TALKBACK

The talkback section has four momentary pushbutton switches, which assign talkback to any combination of AUX Send 1, AUX Send 2, TAPE SUBGRPS (L/R MIX and the 8 SUBMASTERS) and PHONES/STUDIO. Try setting the talkback level at the center detent for starters. It can be tweaked up or down to your liking.

**Note:** When talkback is engaged, **only** the control room outputs are padded by 20dB to avoid feedback, yet still allow the engineer to hear the musicians. **The studio output is not padded.** In situations where either the control room level is set way up, or there is a speaker pointing at the console, there may still be feedback. To prevent this, turn down the talkback level, the control room level, or change the angle of the control room speakers.

The Talkback Microphone is located just above the L/R MIX fader. This ain't no Neumann, so don't attempt vocals through it (we *wanted* it to sound gritty and generally talkback-esque). Application of chewing gum to this orifice will degrade performance further to simulate really beat-up AM radio production studios.

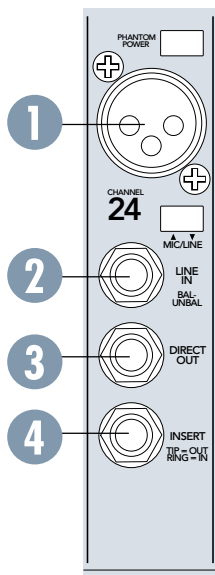

## JACK PANELS (INPUT STRIP & MASTER OUTPUT)

All of the inputs, outputs and insert points are located on the jack panels on the top and the rear panels of the mixer. An external patchbay is not required, although it does make life easier.

Let's start by listing what is NOT on the FRONT jack panel:

- The console outputs to the multitrack tape recorder (the Submaster/Tape outputs)
- The console inputs from the multitrack tape recorder
- The balanced main L/R (XLR connector) outputs (on the rear panel)

All other connections are made at the top of the front panel, either above the channel Input Strips or above the Output Panel.

## INPUT STRIP

Each channel input strip has its inputs and outputs located directly above the strip. The connections are detailed next.

### PHANTOM POWER

Microphone phantom power (+48 VDC) is applied to the channel strips in groups of eight. The phantom *on/off* switch for channels 1-8 is located above channel 8; the switch for 9-16 above channel 16, and so on. It has a “ramping” function, which means it gradually ramps from 0 to 48V when you turn it *on*, and ramps back down when

you turn it *off*. This helps protect your microphones.



We suggest that before plugging or unplugging mics, you turn *off* the PHANTOM power.

Give it about a minute to settle while you get a Diet YooHoo or call your stockbroker. Then connect or disconnect the microphone(s) and turn PHANTOM power back *on*.

**CAUTION:** After switching PHANTOM Power *on* or *off*, wait 1 minute before changing any mic/line switch settings in that eight-channel block.

Another safe alternative is to turn both TRIM and Channel Faders down for that bank of eight channels before switching.

### Let there be light (sockets)

Additionally, one or two BNC connectors (depending upon the number of input channels on the console) are provided above the input strips for gooseneck lamps. The BNCs are wired with the center post at +12 VDC. Mackie doesn't offer lamps, but most dealers do. We recommend LittleLite lamps #12G or #12G-HI (a high-intensity version).

### Mic In

The channel microphone input (1) is a standard 3-pin female mic connector (call me Cannon or call me XLR, just don't call me late for dinner). Pin one is ground, pin two is signal high (+), pin three is signal low (-), as per the (finally) agreed-upon international standard.

**Note:** Don't use these XLR's for line level signals — see “Line In”.

### Line In

The channel Line Input (2) is a TRS (tip-ring-sleeve) balanced 1/4" phone jack, with ground wired to the sleeve, signal high (+) to the tip and signal low (-) to the ring. Nominal input level is +4dBu, with a wide range of levels accommodated by adjustment of the TRIM control. These jacks also accommodate TS (tip-sleeve) unbalanced 1/4" phone plugs. See Appendix A: Connections for more information.

### Direct Out

The channel Direct Out (3) is a nominal +4dBu unbalanced TS 1/4" phone jack, connected to the output of the channel line amplifier post-EQ/post-fader/post-mute. The output signal of each channel strip is always available at the Direct Out jack. Using the Direct Out does not interrupt the normal signal flow through the channel.

### Channel Insert

The channel Insert jack (4) allows you to insert external processing equipment (such as a compressor, gate, you name it) into the main signal path of the input channel strip. The insert point is after the FLIP switch (which also means that it is after the MIC/LINE or TAPE IN preamplifiers) but before the LO CUT filter, EQ and fader MUTE switch. The TRS jack is configured for the Tip (send), Ring (return) and Sleeve (signal ground). See Appendix A for more details on using external processing and channel inserts.



## OUTPUT PANEL

The input and output jacks that correspond to most of the functions in the Output Panel are, logically, located in the jack panel directly above the Output Panel. The 8•Bus outputs to tape (and the inputs from tape) are located on the rear panel.

### Submaster Inserts

At the top of the panel are the eight Submaster Insert jacks (1). These patch points allow you to insert a serial processing device (such as a compressor or an equalizer) into any of the 8•Bus submaster circuits. See Appendix A for more details on using external processing.

The insert point is after the summing amplifier, but before the fader. Like the Channel Insert points, the connectors are 1/4" TRS jacks, wired unbalanced with the output or send signal on the tip, the input or return signal on the ring, and the sleeve common or ground.

**Note:** These inserts can be used as pre-fader direct outs, using an unbalanced (TS) 1/4" plug in these two ways:

- Plugs are inserted just to the FIRST click. There is no interruption of the signal; OR
- Plugs are inserted all the way in to the SECOND click. This interrupts the signal and routes it ONLY to the device you're sending to.

### AUX Sends

The six AUX Sends (2) appear as six 1/4" jacks in a row, just underneath the Sub Inserts.

AUX Sends 1 and 2 are balanced TRS outputs, wired tip to high (+), ring to low (-), and sleeve to ground. AUX Sends 3 through 6 are unbalanced, with the tip high (+) and ring and sleeve tied together as ground. Nominal level is +4dBu.

### AUX Returns

The AUX Returns (3) are stereo, with a L&R input for each return channel. Inputs are 1/4" unbalanced jacks, nominal level (+4dBu).

One special feature: The Left input jack to each return is also labeled "MONO." If you have only one return signal, plugging it into the "MONO/L" jack only will cause it to be connected to both the left and

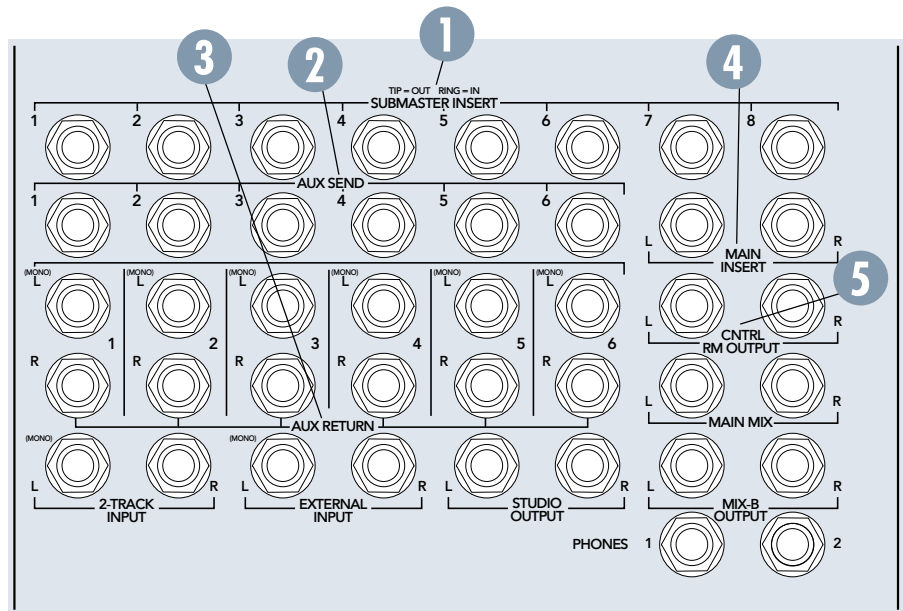

right return inputs and end up centered in your stereo image. When a jack is plugged into the Right input of the return, this mono feature is disabled: the left input is fed to the left return, and the right input is fed to the right return.

### Main Inserts

On the upper right of the panel are two Main Insert jacks (4). These patch points allow you to insert a serial processing device, such as a compressor or an equalizer, into the Main L/R Mix. See Section 4 for more details on using external processing.

The Main Insert's insert point (try saying that fast three times backward) is after the summing amplifier but before the master fader. Like the Submaster Insert points, the connectors are 1/4" TRS jacks, wired unbalanced with the output or send signal on the tip, the input or return signal on the ring, and the sleeve common or ground.

### Control Room Output

The two Control Room Output jacks (5) carry the signal for the Control Room speakers. They are 1/4" unbalanced, wired tip high, ring and sleeve ground. Nominal level is +4dBu. This is where you connect your control room monitor amplifier inputs.

LAYOUT AND FUNCTION

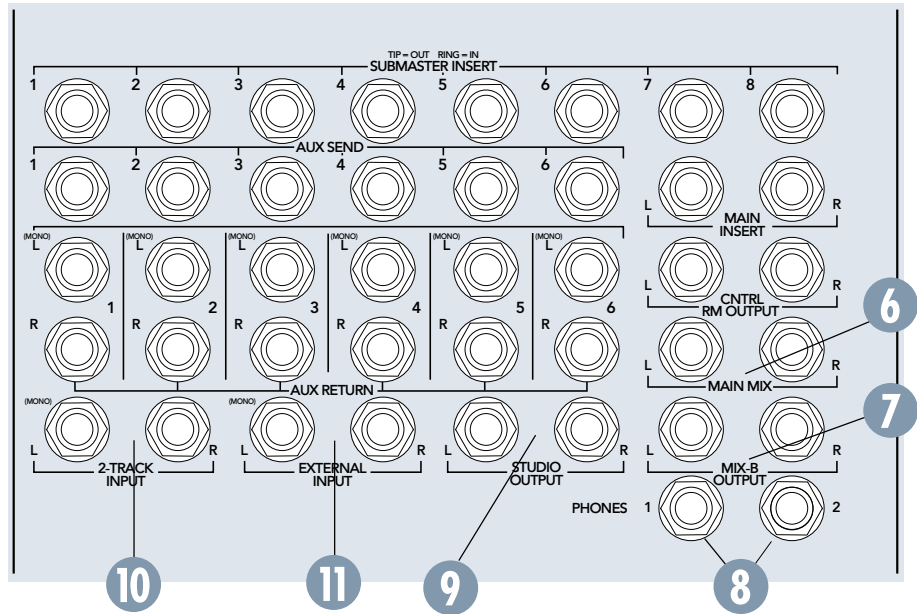

### Main Mix

The Main Mix jacks (6) on the top panel are 1/4" TRS unbalanced, with tip high, and ring and sleeve tied to ground. The nominal level is +4dBu. These two jacks carry the L/R Main Mix, for connection to your master 2-Track recorder's inputs, for instance. The same Main L/R Mix is also available, fully balanced, at the two XLR connectors on the back panel.

### MIX-B Output

The MIX-B jacks (7) are 1/4" TRS unbalanced, with tip high, ring and sleeve tied together as ground, nominal level +4dBu. These jacks make the MIX-B signal available for external patching.

### Phones

The two Phones jacks (8) are 1/4" TRS stereo, with tip connected to left, ring to right and sleeve to ground. The final output of Phones 1 and Phones 2 appear here. These jacks may be connected to external power amplifiers for headphone distribution, or you may plug your phones directly into the jacks. There is plenty of level. In fact, you should turn the PHONES level *down* before you plug your phones in, and then bring the level up to where you want it.

### Studio Output

The two Studio Output jacks (9) carry the signal for the Studio speakers. They are 1/4" unbalanced, wired tip high, ring and sleeve ground, nominal level +4dBu. This is where you connect the inputs to your studio monitor amplifier.

Alternatively, the Studio Output jacks can be wired to a second Control Room amplifier and set of speakers. Then, to switch between the two sets, turn the CNTRL-RM level control fully *down* and turn *up* the STUDIO level control — or vice versa. This concept is very handy during mixdown. It won't work very well if you plan to use any of the talkback switches, as you would during tracking/overdubbing.

### 2-Track Input and External Input

The 2-Track Input (10) and External Input (11) are 1/4" TRS unbalanced jacks, with tip wired to high and ring and sleeve tied together to ground. These inputs offer you the ability to listen to two mono or stereo sources directly, without patching through input channels. Either input can be connected to any stereo source you'd like to listen to. Usually, you will have the 2-Track Input connected to the output of your 2-Track master recorder, to check the mix.

The inputs are directly wired to the "2-TK" and "EXTERNAL" source selection switches in the Phones 1 and 2 and MONITOR sections of the Output Panel. These are +4 dBu inputs.

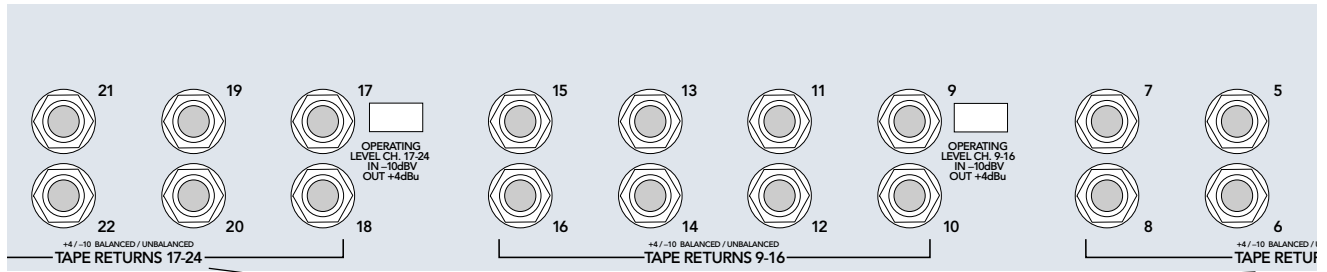

1

## REAR PANEL CONNECTIONS

The connections to and from your multitrack recorder are on the Rear Panel of the 8•Bus Series. There are 24 or 32 Tape Return jacks (depending on the model) and 24 Submaster/Tape Out jacks.

### Tape Returns

The Tape Return jacks (1) are 1/4" TRS balanced, with tip wired to high (+), ring to low (-) and sleeve to ground. These jacks are also wired to accommodate 1/4" TS unbalanced connections. Each jack is connected to the Tape input on the corresponding channel, and is selected by the FLIP switch on that channel.

Connect the outputs of your multitrack recorder to the Tape In jacks. Note that they are grouped in sets of eight: 1-8, 9-16 and 17-24.

#### Tape return OPERATING LEVEL

Nominal level for the Tape Return jacks is switched to either +4dBu (switch out) or -10dBV (switch in) in groups of 8 channels. If you aren't sure of your multitrack recorder's operating output level, check the specifications section of the recorder's owner's manual.

### Submaster/Tape Outputs

The Tape Out jacks (2) are 1/4" TRS balanced, with tip wired to high, ring to low and sleeve to ground. These jacks are also wired to accommodate 1/4" TS unbalanced connections. The Submaster Outputs of the console appear on these jacks in the following pattern:

- Console Bus 1: Submaster 1, 9 and 17
- Console Bus 2: Submaster 2, 10 and 18
- Console Bus 3: Submaster 3, 11 and 19
- Console Bus 4: Submaster 4, 12 and 20
- Console Bus 5: Submaster 5, 13 and 21
- Console Bus 6: Submaster 6, 14 and 22
- Console Bus 7: Submaster 7, 15 and 23
- Console Bus 8: Submaster 8, 16 and 24

Connect the inputs of your multitrack recorder to the Tape Output jacks.

Why are there 24 submaster output jacks on an 8-submaster mixer? This is called "triple-bussing." When you send a signal to Submaster 1 output, for instance, it will appear at Submaster Outputs #1, #9 and #17. Now, whichever tracks on your multitrack are in RECORD mode will accept the signal, while the tracks in SAFE mode won't. That way, you can feed a 24-track deck without having to constantly re-patch. Connect the Submaster/Tape Outputs to the corresponding inputs on your multitrack, using only Submasters 1 through 8 for an 8-track deck, or 1-16 for a 16-track deck.

#### Submaster/Tape Output OPERATING LEVEL

Nominal level for the Submaster jacks is switched to either +4dBu (switch out) or -10dBV (switch in) in groups of 4 channels (3). If you aren't sure of your multitrack recorder's operating input level, check the specifications section of the recorder's owner's manual.

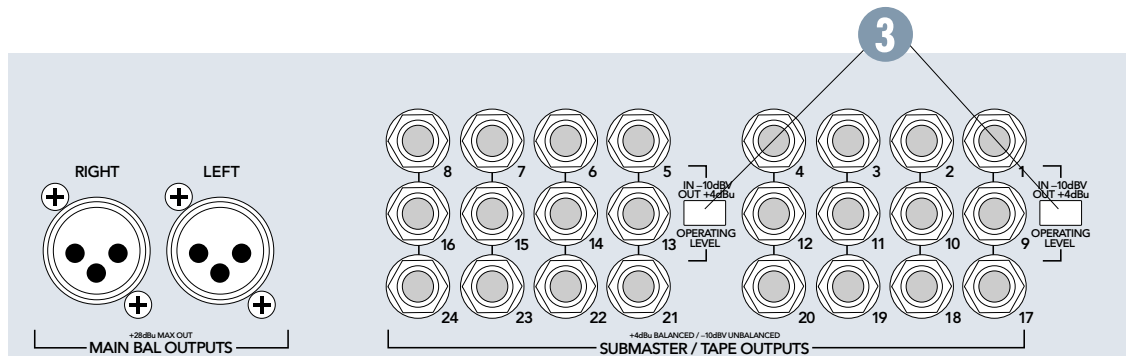

2

3

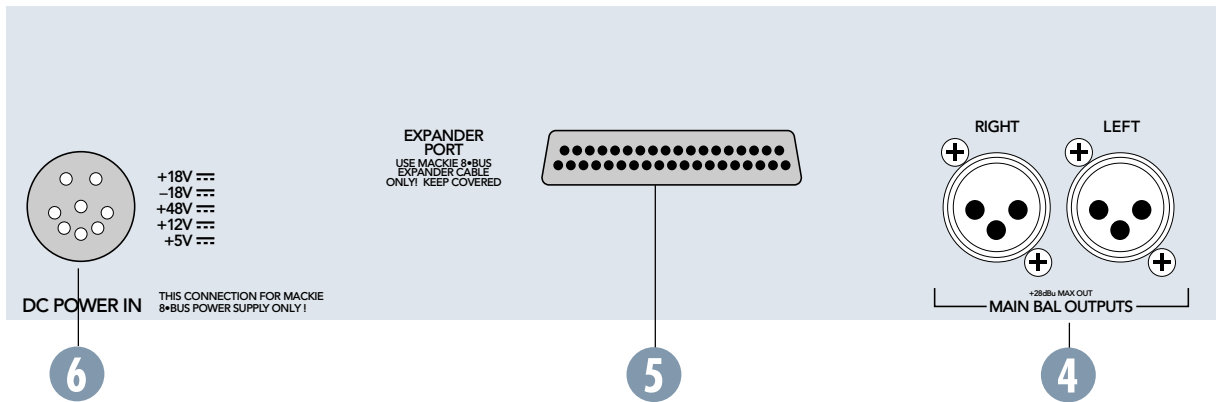

## MAIN BALANCED OUTPUTS

Along with the unbalanced 1/4" TS Main Mix jacks on the front panel, balanced Main XLR Outputs (4) are also provided, wired pin 2 hot, pin 3 cold, pin 1 shield. Maximum output is +28dBu.

## EXPANDER PORT

The Expander Port (5) connection is provided for the 24•E Expander console, which has been discontinued as of this printing.

## DC POWER IN

This is where the funny plug that looks like a Supersoaker squirtgun nozzle fits (6). Your 8•Bus console should ONLY be powered by the appropriate Mackie 8•Bus Power Supply.

This concludes our guided tour of the 8•Bus console's controls and connections. Now it's time for hands-on use!



# SECTION 3: GENERAL INFORMATION

## Do you need to read this section at all?

Many of you reading this manual have a lot of experience in using large mixing consoles. For you battle-scarred pros, Section 2 and the Block Diagram will probably be all that you need to look at.

Then there are those of you who have worked extensively with smaller mixers such as our 1604-VLZ PRO — but who have less experience with a larger, multi-bus console with lots of gazintas and gozoutas. For you, we recommend at least adding Section 4 (Recording) and/or Section 5 (PA) to your reading list. These chapters cover some of the more unusual or less familiar features of your new 8•Bus console.

Finally, there are those who are either new to using mixers or just like to read even larger quantities of our glib prose. For you, we have provided this short section that discusses the basic concepts and procedures used in recording, mixing and sound reinforcement work. If you can make some sense of it, you're ready for the next two sections, which relate these concepts to actually configuring and using a Mackie 8•Bus Series mixing console.

Also, if the system Block Diagram does not look as familiar to you as the menu at McD's, spend a little time in this section.

## GENERAL INFORMATION

Here is a primer covering a few important ideas you should be on good terms with before you sit down to a mixing console.



### LEVELS

Microphones have very low output levels. Power amplifiers have very high output levels. One of the functions of a mixing console is to amplify or attenuate (reduce) these signal levels properly. Since it's easy to degrade the signal by not handling levels well, and since it's your hand on the controls, you should be sure you know how much gain to apply and where to apply it.

### Noise

Every electronic circuit produces noise or hiss or hash or buzz, and any noise present on the input of an electronic circuit will be faithfully passed through. Turn it up high enough, and you will hear the noise.

### Headroom

Every electronic circuit also has a point of overload — a clip point, where the voltage simply cannot rise any higher, no matter what the input signal and your fader move would like. This overload, or clipping, will show up as tooth-grinding distortion.

Somewhere between the noise and the clipping is an optimum level for your signal: high enough above the noise floor to render the hiss inaudible, and far enough below the distortion point to allow range for loud peaks of music to pass without clipping. This safe operating zone might be called operating level or nominal level or zero or perhaps line level. The range between your operating level and clipping is called headroom, which defines just how tall your signal can be without having to duck for the rafters.

Your mission as a designated Master of the Levels is to get the low-level signals up to line-level as soon as possible and to keep them there as much as possible. But don't turn them up too loud.

### Unity Gain

On a Mackie 8•Bus console, the easy way to do this is to set all the level controls according to the Sensitivity Adjustment procedure detailed on page 1.

### Metering

When the meters read 0dB, the level will actually be +4dBu at the outputs (or -10dBV at the submaster outputs, if you've engaged their +4/-10 switches). Don't pay too much attention to the meters. A meter is an aid, a window looking onto part of the dynamic range of your signal, and it will tell you if your level is in the ballpark, so to speak.

Try to keep your signals in the middle range of the meters, for the most part. If the signal is always very low, you may not be getting the best noise figures you can. If the meter LEDs are always solidly lit from bottom to top, you are likely distorting both the console and your recording tape regularly. Keep the signal in the middle, with occasional peaks into the yellow. Remember, the top yellow LED of the meter (+10) represents an audio level of +14dBu, and the Mackie 8•Bus doesn't clip until +28dBu. Even banging the meters hard, you still have around 14dB of headroom for your peaks. (The L/R meters have an additional red LED segment to show clipping at +28dBu.). There are not

GENERAL  
INFO

many recorders, and no amplifiers, that can tolerate such high signal levels. Therefore, it's best that the red LEDs never light up.

But, if your music is sounding good, don't worry if you're in the yellow a lot or if some parts of the track hardly read at all. You'll quickly get a feel for what works for you, when you can get away with really smacking the tape or the electronics too much.

## BUSES

More often than not, the goal in a mixing console is to mix two or more inputs into one output. Like a coach who has two or more players to get to the same ballgame, console designers use a bus. Even Webster's Unabridged Dictionary agrees, defining the word bus in electronics as "a conductor serving as a common connector for three or more circuits."

The Mackie 8•Bus Series has, in fact, many more than eight buses. The eight memorialized in the name are important, but there are also six AUXiliary buses, a pair of L/R Mix buses, the alternate pair of MIX-B buses, and a pair of Solo buses. We will try to be clear just what bus we are talking about when we do talk about buses.

## SENDS AND RETURNS

Sends are outputs, and returns are inputs. So why don't we call them outputs and inputs?

Well, actually, the terms send and return can mean many things, but the way they are generally used in mixing console parlance is to refer to sends, which tap off a little of a signal to send to some effects device (like a reverberation unit), and returns, which function to return that reverb back into the mix.

Sends are also used to tap some mix of signal from a collection of channels for a headphone cue mix. For that matter, sends can be used as additional mix buses, if needed.

In the same way, if you don't need them for reverb or effects, returns can be used as additional inputs to your mix.

## SOLO

Solo is a standard console function that allows you to listen to one or more sources all by themselves (soloed).

You can check EQ, possible distortion or buzz, or just listen to see if a particular mic is open or not. This function can also be handled by each channel's -20/OL LEDs. See Section 2 "-20 and OL LEDs" for more details. When soloing more than one source, you can listen to the blend of just part of your mix: only the sopranos, for example, or just the tom mics on the drums.

The solo circuits are designed not to interrupt the recording process. The solo bus signal is sent directly to the control-room monitors without affecting any of the inputs, outputs or recording buses.

When you are mixing or monitoring with reverb, remember to not only solo the channel you'd like to hear, but also the AUX Return carrying your reverb. Otherwise, you will hear the channel soloed dry, without its echo.

## EQ

Everybody knows what EQ is, but just in case you'd like a refresher, we'll put in a few paragraphs here.

Equalization (EQ) refers to purposely changing the frequency response of a circuit, sometimes to correct for previous unequal response (hence the term, equalization), and more often to add or subtract level at certain frequencies for a pleasing effect.

Bass and treble controls on your stereo are EQ; so are the devices called parametrics and graphics and notch filters.

A lot of how we refer to equalization has to do with what a graph of the frequency response would look like. A flat response (no EQ) is a straight line; a peak looks like a hill, a dip is a valley, a notch is a really skinny valley, and a shelf looks like a plateau (or a shelf). The slope is the grade of the hill on the graph. For instance, if you lived in Texas, you would set y'all's EQs flat.

Graphic equalizers have enough frequency slider controls to form a graph of the EQ right on the front panel. Parametric EQs let you vary several EQ parameters at once. A filter is simply a form of equalizer that allows certain frequencies through unmolested and either reduces other frequencies or eliminates them entirely.

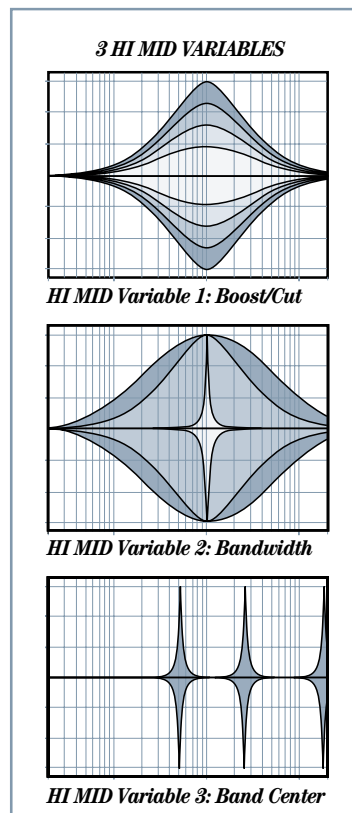

Fig.1

The equalizer on the 8•Bus Series combines several different types of EQ into five different sections.

The HI MID EQ section is a fully parametric equalizer. This means all the significant parameters can be varied, as you can see in Figure 1. The boost or cut of this section, through a range of  $\pm 15\text{dB}$ , is set with the top knob. The center frequency is dialed in with the middle knob, and can be set anywhere between 500Hz and 18kHz.

Finally, the bandwidth of the bell-shaped response curve around the selected frequency (also somewhat inaccurately referred to as a ratio known as Q) can be selected with the lower knob. The range is from as wide as 3 octaves to as narrow as 1/12 octave. Leave it at the center detent if you are unfamiliar with the bandwidth feature. This setting will give you a semi-parametric type of EQ.

The 8•Bus console's set of three HI-MID controls (boost/cut, frequency center and bandwidth) is VERY powerful in its effects. Rarely if ever will you need more than a few dB of boost and cut or, as noted above, will you want to stray from the NORMAL (2 octave) bandwidth until you gain some experience recording and mixing.

The LO MID EQ section is called a semi-parametric equalizer, because the bandwidth is not adjustable (Figure 2). The frequency range is 45Hz to 3kHz and the bandwidth is fixed at 2 octaves.

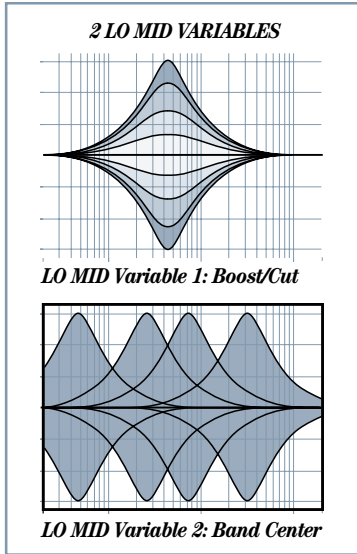

Fig. 2

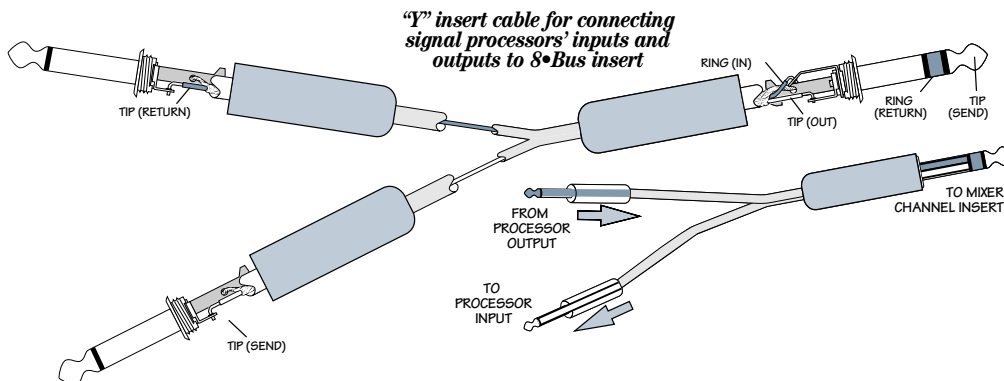
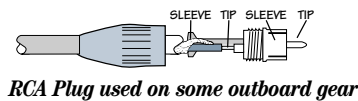
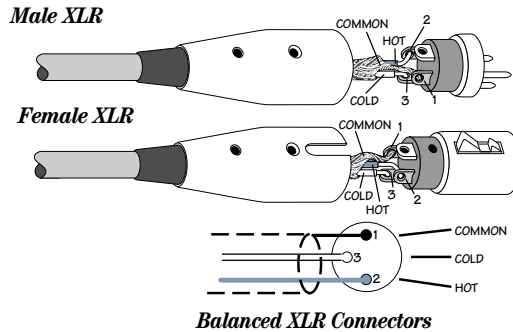
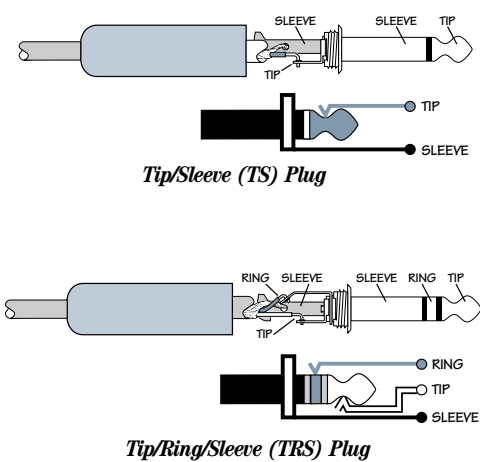
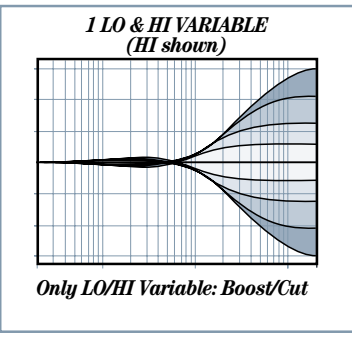

Figure 4: Common Connectors

**GENERAL INFO**



**Fig. 3**

The LO and HI sections of the EQ are shelving equalizers, with a family of curves shown in Figure 3. As you can see, shelving EQs lift or lower the entire range of frequencies above or below a certain

point. Most tone controls on stereos are shelving EQs, often set at 100Hz for the bass and 10kHz for the treble. The LO EQ on the 8•Bus is at 80Hz and the HI is at 12kHz.

The EQ IN/OUT SWITCH will completely remove the EQ circuit from the channels signal path when disengaged, and activate the EQ when engaged.

When the EQ section is split between the channel strip and Mix B, the EQ IN/OUT switch will only shut off the HI MID and LO MID bands.

The LOW CUT filter (also known as a high-pass filter) reduces everything below about 100Hz. 75Hz is -3dB, and the lower the frequency, the greater the attenuation. The slope of the filter is 18dB/octave.

**Connectors**

If you've used a Mackie VLZ PRO compact mixer, you're familiar with the various kinds of connectors used with a mixing board. If you're new to this whole thing, review the drawings in Figure 4 on Page 21. They're also described in detail in Appendix A on page 44 of this manual.

**A BIT MORE ON MIX-B/FLIP**

In Section 2, we described FLIP's use during tracking and mixdown. Before you actually get involved with recording, we'd like to spring a couple of block diagrams on you that may clarify things further.

The switch labeled FLIP selects the input that is actually fed into the channel fader (and the MIX-B control).

As the label indicates, the MIC/LINE input (after Mic/Line preamp) is fed to the channel fader when the FLIP switch is in the *up* position (Figure 5). When FLIP is *up*, the channel is fed MIC/LINE and MIX-B gets TAPE. That way, you can use MIX-B to monitor the signal as it comes back from the recorder. This is the normal mode for tracking and overdubbing.

In the *down* position, the TAPE return (the output signal from the corresponding track of your recorder) is fed to the channel fader (Figure 6). When FLIP is *down*, the channel input is TAPE and MIX-B receives MIC/LINE. That enables you to use each channel's MIC/LINE input for another input during mix down. Thus *down* is the normal position for mixing.

For PA, leave the FLIP switch *up*.

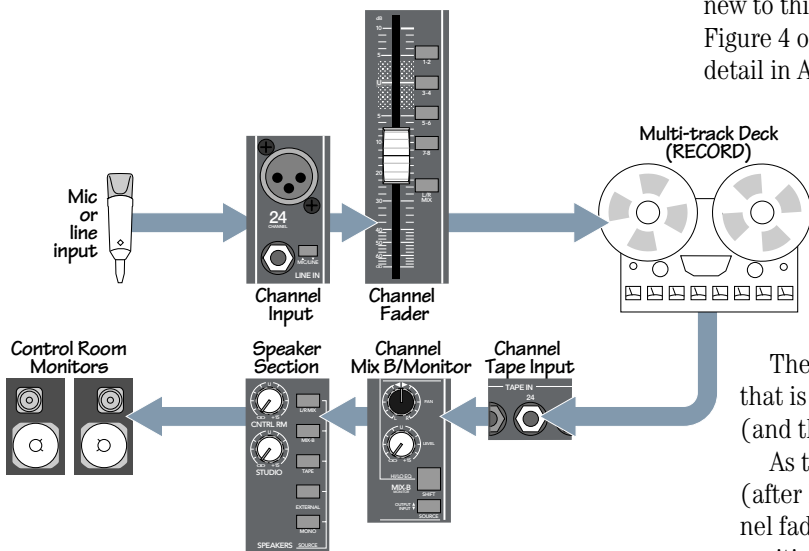

**Figure 5: FLIP/MIX-B signal path during tracking ("flip" switch up)**

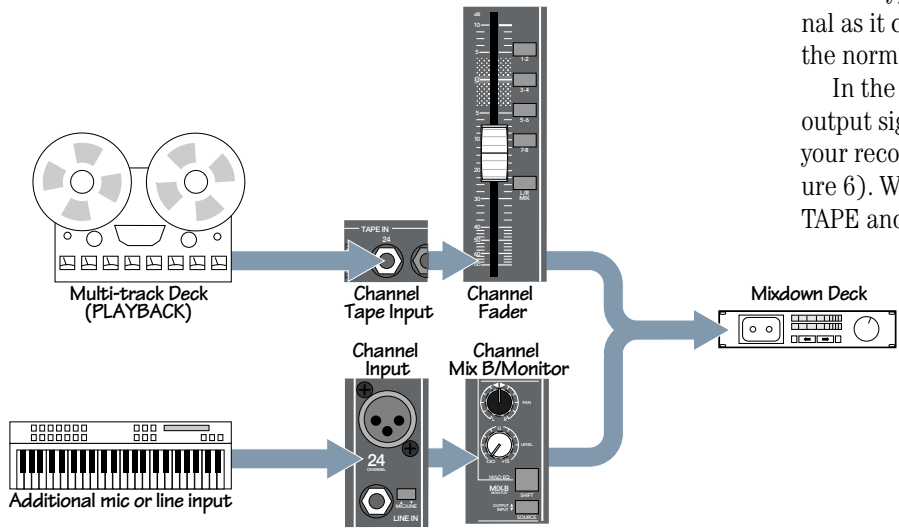

**Figure 6: FLIP/MIX-B signal path during mixdown showing additional input ("flip" switch down)**



# SECTION 4: RECORDING WITH THE MACKIE 8•BUS CONSOLE

## RECORDING OVERVIEW

The recording process can be as simple as one microphone recorded on a monaural tape recorder. Not much advice needed for that.

But since you've bought such a large mixing console, we expect you'll occasionally be doing pretty big sessions. This section will describe at least one way of approaching a large session—for example, a big drum set, bass, guitar, piano, scratch vocal and horns, with background vocals and synthesizer overdubs. Let's assume there is a 16-track recorder already patched in to the first 16 Tape In and the 16 Tape Out jacks on the 8•Bus Console. There is a set of Master Tracking, Overdub and Mixdown drawings farther on in this section for general reference.

## SETUP

Okay, now let's get ready for your session. Make a diagram of your studio setup showing mic positioning. Then assign an input channel to each mic.

Trying to make your microphone-to-input layout sensible now will avoid confusion later. Group similar instruments together. If there is a left-to-right pattern to the mics (like drums mics or a vocal group), keep the same left-to-right sequence on the console. Plan your basic track assignments the same way. It's very confusing to have inputs randomly strewn across a mixing console.

Now, normal your console (also called "zeroing"). This means check the position of every switch and every knob to be sure they are in the normal position. Your normal may be different from someone else's, but generally it means all switches off or up, all knobs either all the way down or at their Unity detent. If you are working in a certain mode, say, for example, all AUX 3-4 SHIFT switches in TAPE, this is the time to set them all.

Lay a piece of 1/2" or 3/4" white paper tape across the top of the input faders and label all your inputs. (By the way, avoid masking tape. It will slime your console. Take the time to go to an art supply store or a recording supply store and get some better-quality "low tack" tape.)

Since your multitrack returns will be coming into the MIX-B inputs on some of the same input strips, you might want to divide your label into multitrack track labeling and input labeling. See TRACKING drawings 1&2 on pages 25 and 26.

If you have any careful submixing to do during the recording, you might want to lay strips of 1/4"

white paper tape alongside each fader slot (bus faders too, if you need them). Then you can mark your place as you rehearse your fader moves.

## RECORDING AND OVERDUBBING

### Using Buses

If you have to combine two or more inputs into one output (two trumpets on one track, five drum mics panned across a pair of tracks), you must assign the inputs to a common bus or pair of buses.

If you have only one source going to one tape track, you have a choice: you can assign the channel to the bus feeding that track, or you can patch the tape track into the channel's Direct Out.

Rationale for using a bus:

- It's there, it's easy, it sounds great.
- You meet interesting people on the bus.

Rationale for using a Direct Out:

- You've already assigned all eight of your buses to other duties.
- You are a purist and you think you can hear the additional circuitry used in a bus.

### Monitoring

The most straightforward way to monitor during a recording or overdubbing session is by listening to the output of the recorder, played through MIX-B. Properly configured, your recorder will automatically switch between source and playback as you put the deck into stop, play, fast wind, record and so on. That way, you're always hearing your instruments after they travel through the multitrack deck, regardless of whether or not the tape is rolling.

MIX-B allows you to set up a custom mix of the tape tracks, independent of your recording levels. You can set level, pan, reverb and even EQ in your monitor mix while you record. You can even patch a cassette recording into the outputs of MIX-B for a rough mix of the session.

Both the FLIP and MIX-B SOURCE buttons should be in their *up* positions. This connects the Tape In amplifier to the MIX-B level control, and MIX-B will monitor the recording machine.

### Cue Mix

Initially, as you are setting up, set the Phones source to the MIX-B selection. This way, the musicians will at least have something to listen to right away so they can tune up and rehearse,





### FOLLOW THIS LEVEL-SETTING PROCEDURE FOR EACH CHANNEL IN USE:

1.  Assign signal to channel fader:
  - If channel will be used with a microphone, MIC/LINE switch should be *up* & FLIP switch should be *up*.
  - If channel will be used with line input, MIC/LINE switch should be *down* & FLIP switch should be *up*.
  - If channel will be used with a tape input, the FLIP switch should be *down*.
2. Set channel strip controls as follows:
  - TRIM pot all the way counterclockwise (+4dB)
  - AUX SEND controls all the way counterclockwise (*off*)
  - EQ switch *up*
  - LOW-CUT switch either *on* or *off* (*on* recommended for mic inputs)
  - Channel fader at UNITY
  - SOLO switch *down*
3.  Make appropriate “noise” into the channel input. For example, have a performer play/sing/strike something or someone, etc. at the level they’re going to record or perform. Don’t just play a single sustained note, but rather, jam away as you would be during recording or performance. If the channel is being used for a tape input during mixdown, roll an already-recorded track from your recorder.
4. The channel’s –20dB LED should light. The L/R main meters will show the actual internal operating level of soloed signals. Now you will optimize levels.
5. 
  - For mic or line inputs, adjust the TRIM control clockwise to get peaks that regularly hit 0dB on the L/R meters.
 OR
  - For tape inputs, set the +4/–10 switch on the console back panel to its *in* position (–10) if the signal peaks are below –10dB on the L/R main meters.
6. If desired (optional):
  - Press the EQ switch *in*.
  - Adjust the channel strip’s EQ to about what you will be using during the session.
  - Re-perform Step 5.
7.  Return the channel strip’s SOLO button to its *up* position.
8.  Repeat Steps 1-7 on the next channel that is being used.

providing all your chosen tracks are in record mode and auto-switching to input when tape is not rolling.

Keeping the Phones on MIX-B may work for the entire session, but usually the musicians will want one or even two custom mixes. The bass player and drummer may want bass and drums featured very loud in their cans, which may be killing the vocalist. Likely, as soon as you are close, you will be required to come up with some new cue feeds for the players.

AUXiliary Sends 3-4 and 5-6 are designed to set up two different cue mixes from the same source as MIX-B, which should be the signal from your recorder. Simply push the SOURCE button by Sends 3-4-5-6 down to the MIX-B position, and push the PRE button down (to bypass the MIX-B level control). With the system configured like this, you will be able to send a custom mix from each tape track to either Sends 3-4 or Sends 5-6, depending on the position of the AUX SHIFT switch. It’s like having an extra Mix B section.

Sends 3 and 5 are set to feed the left headphone, and 4 and 6 the right headphone. An equal setting on both knobs will place the sound in the center of the image.

**Additional Note:** You can modify the channel Aux 1/2 sends to source the pre-fader information from the tape returns. This would provide an additional two aux sends that could be used as cue mixes from Mix-B (tape returns), and allow all six aux sends to access Mix-B during tracking or overdubbing for cue mixes as well as effects. Instructions for this modification can be found on our website at [www.mackie.com](http://www.mackie.com) (click on Support). Or you can call Tech Support at 1-800-258-6883 for assistance.

### Wet or Dry Monitor?

Usually, you will not record wet (with reverb) onto your multitrack master. You can’t undo it later. However, it is nice to hear a little echo on the tracks as you are working, and with the 8•Bus Series, you have the option of wet monitoring.

Since you are using MIX-B as your monitor submix, you should derive the reverb send from the same source. When the SOURCE button next to Sends 3/4/5/6 is depressed but the PRE button is not, the sends are connected after the MIX-B level control and make great wet monitor reverb sends.

Once you have your sends happening, you can assign the return from your reverb into the headphone cues by using Stereo Returns 3 or 4, which can directly assign into the phones. (Even if you are using Send 6, there is no reason not to patch the output of the reverb into Returns 3 & 4. The Send and Return numbers do not have to match.)

*Text continued on Page 27*

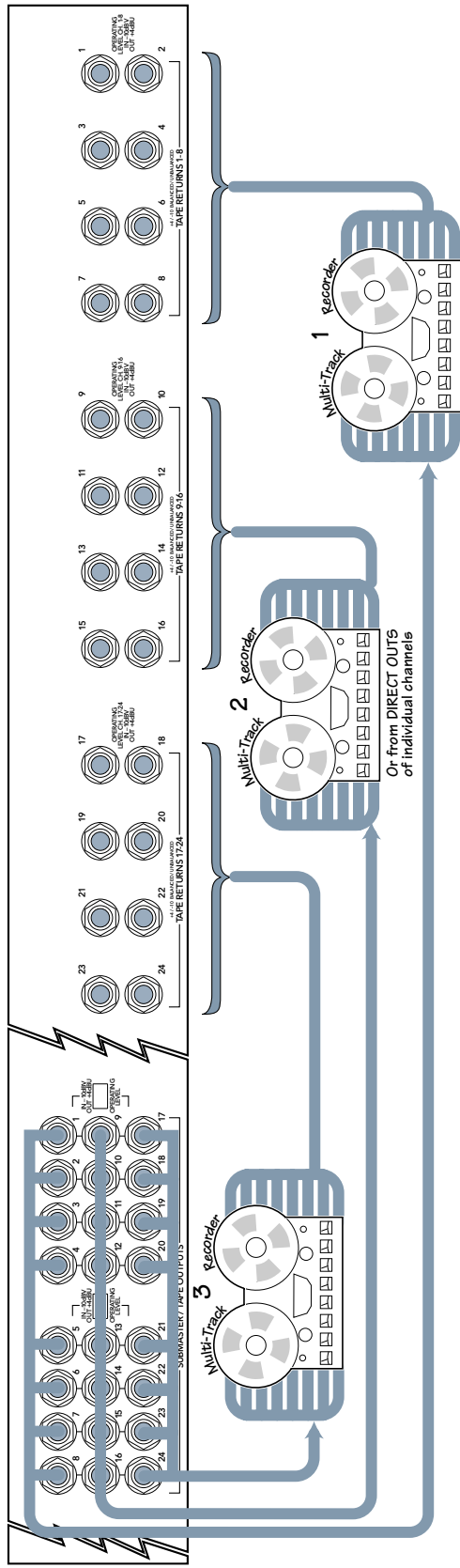
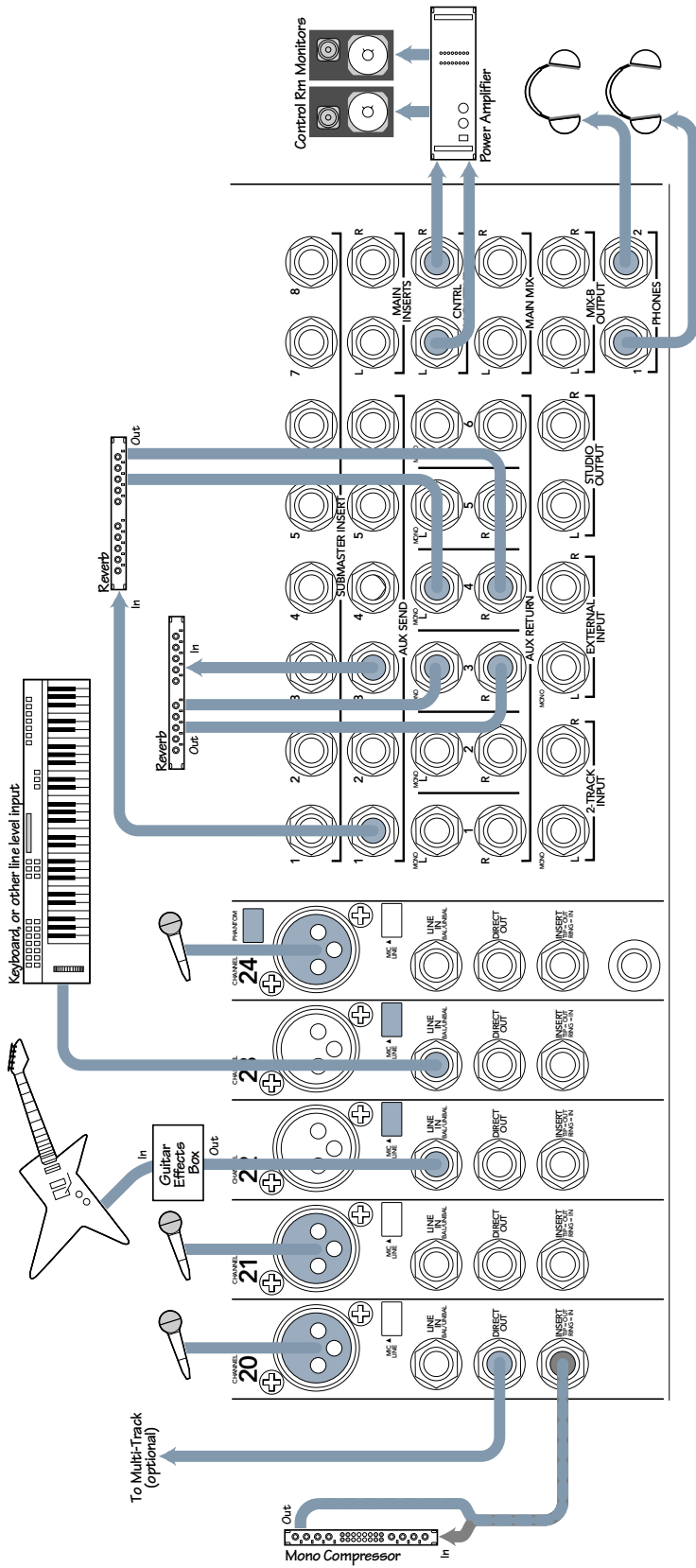

**TRACKING PART 1: INPUT/OUTPUT**

Assign channels to the appropriate bus for the desired tape channel input.

Channels 20, 21, 22, 23, and 24 control section. Each channel includes: TRIM (0-10), MIC/LINE 4 (checkbox), TRIM OVER (checkbox), FLIP (checkbox), AUX 1-6 (knobs), PRE (checkbox), RE (checkbox), SHFT (checkbox), CHANNEL MIX (checkbox), SOURCE (checkbox), EQ (HIGH, MID, LOW), EQ IN (checkbox), EQ OUT (checkbox), PAN (knob), LEVEL (knob), SOLO (checkbox), MUTE (checkbox), and a vertical fader with 12 tap points (1.2, 3.4, 5.6, 7.8, LR MIX).

**MACKIE. 24x8x2 8-BUS MIXING CONSOLE 24-8**

POWER (checkbox)

Channels 1-6: LEVEL (knob), SOLO (checkbox), BALANCE (knob), PHONES (checkbox), PHONES LR MIX (checkbox), ASSIGN (checkbox), LR MIX (checkbox), SOLO (checkbox).

AUX SENDS: MIX-B LEVEL (knob), PHONES LEVEL (knob), MONITOR (checkbox), MIX-B (checkbox), PHONES 1 (checkbox), PHONES 2 (checkbox), MONITOR (checkbox), SOLO (checkbox), TALKBACK (checkbox).

STEREO AUX RETURNS: AUX SEND 1-2 (knobs), TALKBACK (checkbox), PHONES (checkbox), SOLO (checkbox).

MAIN OR SOLO LEVEL: 24 vertical faders (1-24) with L/R indicators.

LEFT/RIGHT MIX: TALKBACK MIC (checkbox), LEFT/RIGHT MIX (checkbox).

Tinted knobs are used in this application

Tinted buttons are pressed IN

**TRACKING PART 2: THE BOARD**

Getting reverb into the monitors is a little more involved, since there is no return assignment switch to MIX-B. You have three choices:

- Assign MIX-B to L/R Mix in the MIX-B master section. Then, select L/R Mix as your only source in the monitor section. Finally, use Stereo AUX Returns 1-6 to bring the reverb into the L/R Mix buses. Make sure that none of the channel L/R switches are engaged. There is no disadvantage to this patch, unless you are already using the L/R Mix buses for some other function.
- Patch the returns into unused tape returns, using the Tape In jacks on the rear of the console. Then route them into MIX-B, just as if they were additional tape tracks.
- Patch the returns into unused channel strips, using the Line In jacks. Then you can route the reverb anywhere your heart desires.

### Let's Record!

Here's one way to set the board up (another option is shown in the hook-up drawings...either works just fine):

*Kick Drum ..... to Channel 1 ..... Direct Out to Track 1*  
*Snare Drum ..... to Channel 2 ..... Direct Out to Track 2*  
*Cymbals Left ..... to Channel 3 ..... Bus 3 to Track 3*  
*Cymbals Right ..... to Channel 4 ..... Bus 4 to Track 4*  
*Tom 1 ..... to Channel 6 ..... panned between Buses 3 & 4 to Tracks 3 & 4*  
*Tom 2 ..... to Channel 7 ..... panned between Buses 3 & 4 to Tracks 3 & 4*  
*Tom 3 ..... to Channel 8 ..... panned between Buses 3 & 4 to Tracks 3 & 4*  
*Bass Amp ..... to Channel 9 ..... Bus 5 to Track 5*  
*Bass Direct ..... to Channel 10 ..... Bus 5 to Track 5*  
*Scratch Vocal ..... to Channel 11 ..... Direct Out to Track 11*  
*Guitar near ..... to Channel 12 ..... Bus 6 to Track 6*  
*Guitar far ..... to Channel 13 ..... Bus 6 to Track 6*  
*Piano L ..... to Channel 14 ..... Bus 7 to Track 7*  
*Piano R ..... to Channel 15 ..... Bus 8 to Track 8*  
*Trombone I ..... to Channel 16 ..... panned between Buses 1 & 2 to tracks 9 & 10*  
*Trombone II ..... to Channel 17 ..... panned between Buses 1 & 2 to tracks 9 & 10*  
*Flugelhorn ..... to Channel 18 ..... panned between Buses 1 & 2 to tracks 9 & 10*  
*Trumpet ..... to Channel 19 ..... panned between Buses 1 & 2 to tracks 9 & 10*

Your monitoring and cue signals come from the MIX-B inputs corresponding to the tape tracks:

*Kick ..... Track 1 ..... Tape Return 1 ..... MIX-B*  
*Snare ..... Track 2 ..... Tape Return 2 ..... MIX-B*  
*Drums L ..... Track 3 ..... Tape Return 3 ..... MIX-B*  
*Drums R ..... Track 4 ..... Tape Return 4 ..... MIX-B*  
*Bass ..... Track 5 ..... Tape Return 5 ..... MIX-B*  
*Guitar ..... Track 6 ..... Tape Return 6 ..... MIX-B*  
*Piano L ..... Track 7 ..... Tape Return 7 ..... MIX-B*  
*Piano R ..... Track 8 ..... Tape Return 8 ..... MIX-B*  
*Horns L ..... Track 9 ..... Tape Return 9 ..... MIX-B*  
*Horns R ..... Track 10 ..... Tape Return 10 ..... MIX-B*  
*Scratch Vocal... Track 11 ..... Tape Return 11 ..... MIX-B*

At this point, your recording should pretty well take care of itself. Keep on top of the players: be sure they're in tune, keep them tight. You'll have great tracks before midnight.

### Overdub, Anyone?

See the OVERDUB drawings on page 30 and 31.

Once you've got your basic tracks down, take a moment and log all your settings, right down to headphone sends and outboard compressor thresholds. You may be back next week doing it all over again, and you won't remember it all. It seems some engineers use a camera for this step, but our Polaroids never come out that well.

One easy way to do this is to copy the 8•Bus panel layouts from the end of the manual and mark your settings on them in color.

Now, normal all the channel inputs and EQs and sends—anything that does not affect your MIX-B monitor and cue submix. Do not change the FLIP switch settings yet.

Then, pick a convenient input channel or two and use them as your input for overdubs. As you record on different tracks, just reassign the bus outputs from the channels, no sweat. Remember, with the triple busing feature, explained in Section 2 (“Submaster/Tape Outputs”), you won't have to repatch anything to feed up to a 24-track

recorder. And your monitor mix and cue mix haven't changed. At the end of the night, you can run the monitor mix into a cassette or DAT and take a rough mix home.

If you're going to do your final mix right away, you have another option during overdubbing. First, pick an input channel for your overdub mics beyond the number of tape tracks you have. If you have a 16-Track, choose channels 17 and 18. These will be your inputs, which you will then assign to open tape

tracks for the overdubs. Now, push the FLIP buttons on channels 1-16. This will bring the Tape Inputs into the main channel faders, and you can begin working on your mix while you monitor on the L/R Bus. Headphones can still be fed via the AUX Send of your choice, or by assigning monitor to the phones. When you're done overdubbing, your mix is ready.

### MIXING OVERVIEW

See the MIXDOWN drawings on pages 31 and 32.

Recording and overdubbing require care from the recording engineer, but the focus really has to be on the performances. It's important to get a good sound, but it's more important to keep the musicians really in it, keep the pace up, be ready to snag that killer track when it happens.

Good mixing, however, focuses solely on the engineer and requires an emphasis on precision



and meticulous setup. Creatively, you must blend the tracks so they at least sound like music again; technically, you must take into account the sound of home and car speakers, mono compatibility, human perception changes under different listening conditions, matching similar product in your market, not to mention tonal and level balance between songs, and meeting the criteria for tape and disc mastering.

## MIXING SETUP

Clean and align your mixing machine according to the manufacturer's instructions. If it's a digital machine, sacrifice a full floppy disk in its presence to ensure smooth operation during mixdown.

Group all your inputs in some sensible way, keeping drums, vocals and synths next to each other.

You'll probably have to repatch some of your tape returns to do this. Lay a strip of 1/2" white tape across all the console input channels for labeling. Put 1/4" strips of tape vertically along each fader to mark levels.

### Pick a Model

Get copies of music you'd like to approximate in your mix, and patch the CD or DAT machine into the external jacks on the console. Then you can A-B your mix against your model at the flick of a switch to see if you're really getting that snare sound or not.

### Consider Compression

You can mix an entire project without a lick of compression; many engineers do. The dynamic range of a CD can certainly handle it. But consider: most people listen to what you mix under less than ideal conditions. There is background noise and road noise, and most people don't listen as loud as you mix. A little gentle compression, whether on individual tracks or on the entire mix, can reduce the dynamic range a bit and pull your mix together. Also, if you want to simulate what your mix will sound like over the airwaves, you can compress the heck out of it, like they do. They use very fancy compressors, but any compressor will give you an idea of what will happen. This is good for checking things out, but not for your final mix.

## DOING THE MIX

Assuming the console has been normalled, all you have to do to get ready to mix is to engage the FLIP and L/R MIX switches (unless you are using the submasters to group channels) on each of the input channels and select L/R MIX as your Monitor Source. Pull all the channel input faders down.

There is a tendency for levels to creep upwards as you add more and more tracks to your mix. One way to keep a handle on this is to set the L/R master fader a few dB above unity, and to set your initial monitor levels pretty high. As you get closer and closer to your final, you can ease the monitor levels down and ease up the master fader to unity, which is where it should be.

If your multitrack tape machine will do it, put it in the loop mode so it will just play the song over and over. Start mixing a group of tracks that run throughout the song, maybe drums or the rhythm section.

Set the panning, level, EQ, reverb and delay, and bring in more tracks as the mix begins to jell. Don't make any level marks on your fader tapes yet, but as the mix comes together, try to note which sections work without a lot of fader moves. Look for what appears to be the loudest part. Sometimes turning the Control Room Level way down, so the mix is very quiet, will reveal what sounds are clearly louder than others.

Now take a listen to your model on CD or DAT. Make some adjustments in your mix to put it closer. When you think it's getting reasonable, find that loudest section that you located, and pull the master fader back to get the levels close to normal on the main meters. Then go to the section that works by itself and start making little marks on the fader strips. You're getting close.

Listen to the model again. Start making more marks for the moves. Repeat until it sounds like a hit. Serves four adults.

## Using External Processing

Compressors, gates and equalizers are generally inserted into the signal path. They are referred to as "*serial devices*," used in series with the signal path. *All* the signal goes into the device, then out and back to the mixer's signal path.

Reverb, echo, delay, aural excitement and spatial enhancement are usually set up as send/return devices. These are referred to as "*parallel devices*." Some amount of signal is "borrowed" from a channel via an AUX Send, sent to the device, processed and returned to the mixer as a new, wet signal via the AUX Returns, to be mixed with the original, dry signal.

### Insert Devices

A compressor/limiter after EQ will compress differently than one inserted before the EQ. A compressor/limiter inserted before a master fader will limit consistently, but one after the same fader will effectively have its threshold moved by the fader level. None of these choices are right or wrong, they just have different effects.

*Text continued on Page 35*

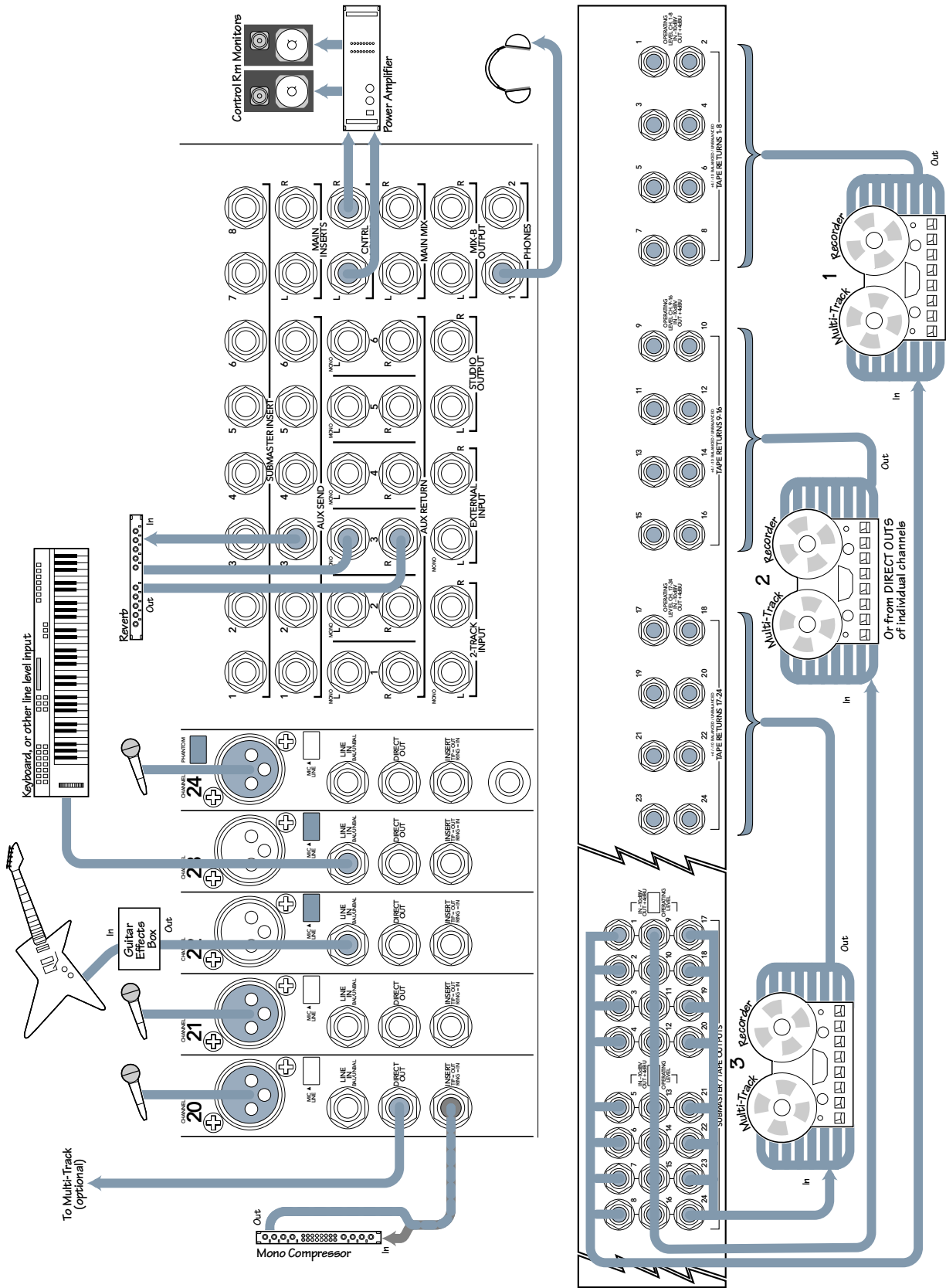

**OVERDUBBING PART 1: INPUT/OUTPUT**

Assign channels and adjust panpot to the appropriate bus for the desired tape channel input.

**MACKIE.**  
24x8x2 8-BUS MIXING CONSOLE  
**24•8**

Tinted knobs are used in this application

Tinted buttons are pressed IN

**OVERDUBBING PART 2: THE BOARD**



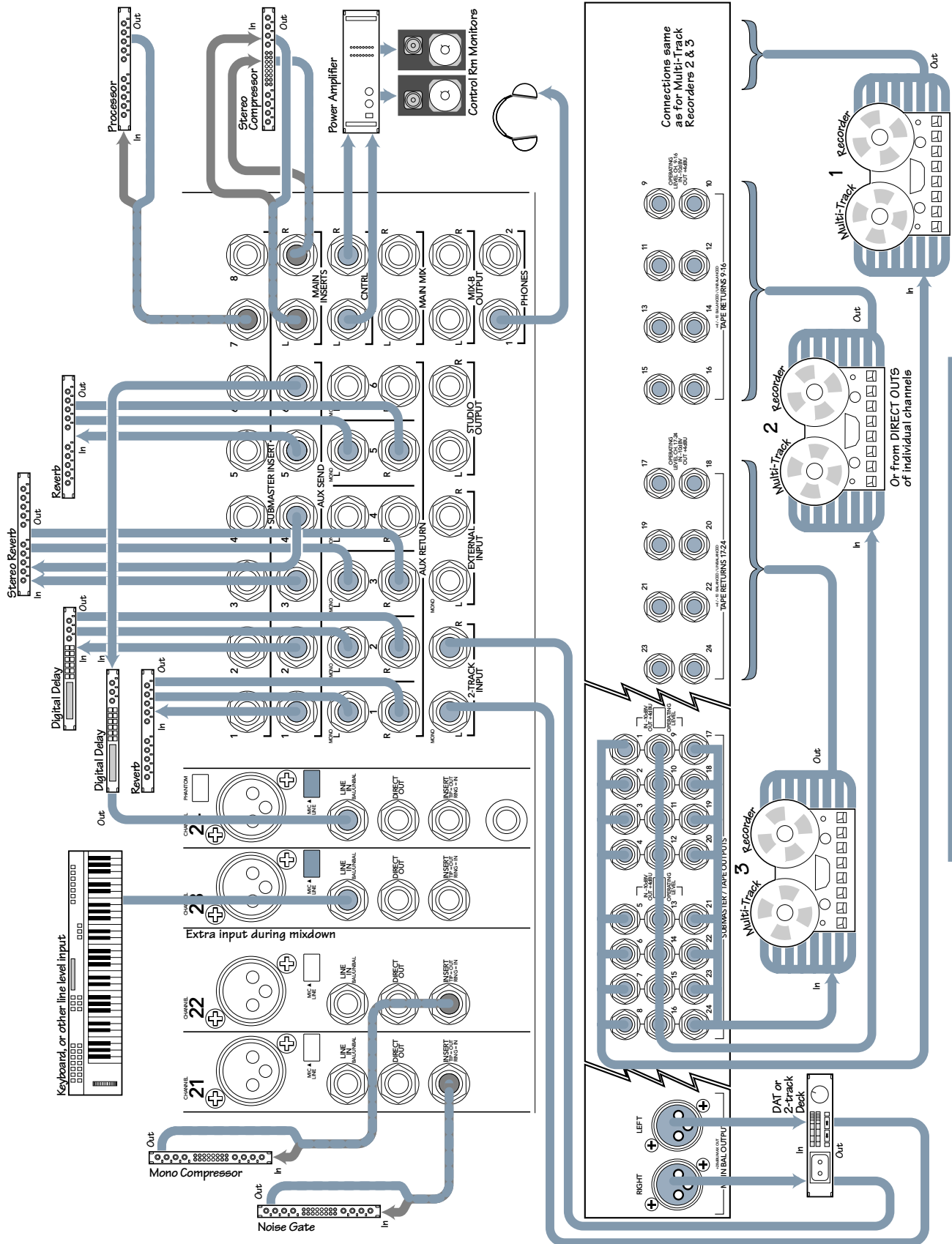

**MULTITRACK MIXING PART 1: INPUT/OUTPUT**

Drums

Bass Guitar

Guitar

Keys

Vocals

Keys

Vocal Delay

**MACKIE**  
24x8x2 8-BUS MIXING CONSOLE  
**24•8**

Drum L

Drum R

Rev 1 L

Rev 1 R

Vox L

Vox R

Keys 1

Keys 2

Tinted knobs are used in this application

Tinted buttons are pressed IN

**MULTITRACK MIXING PART 2: THE BOARD**

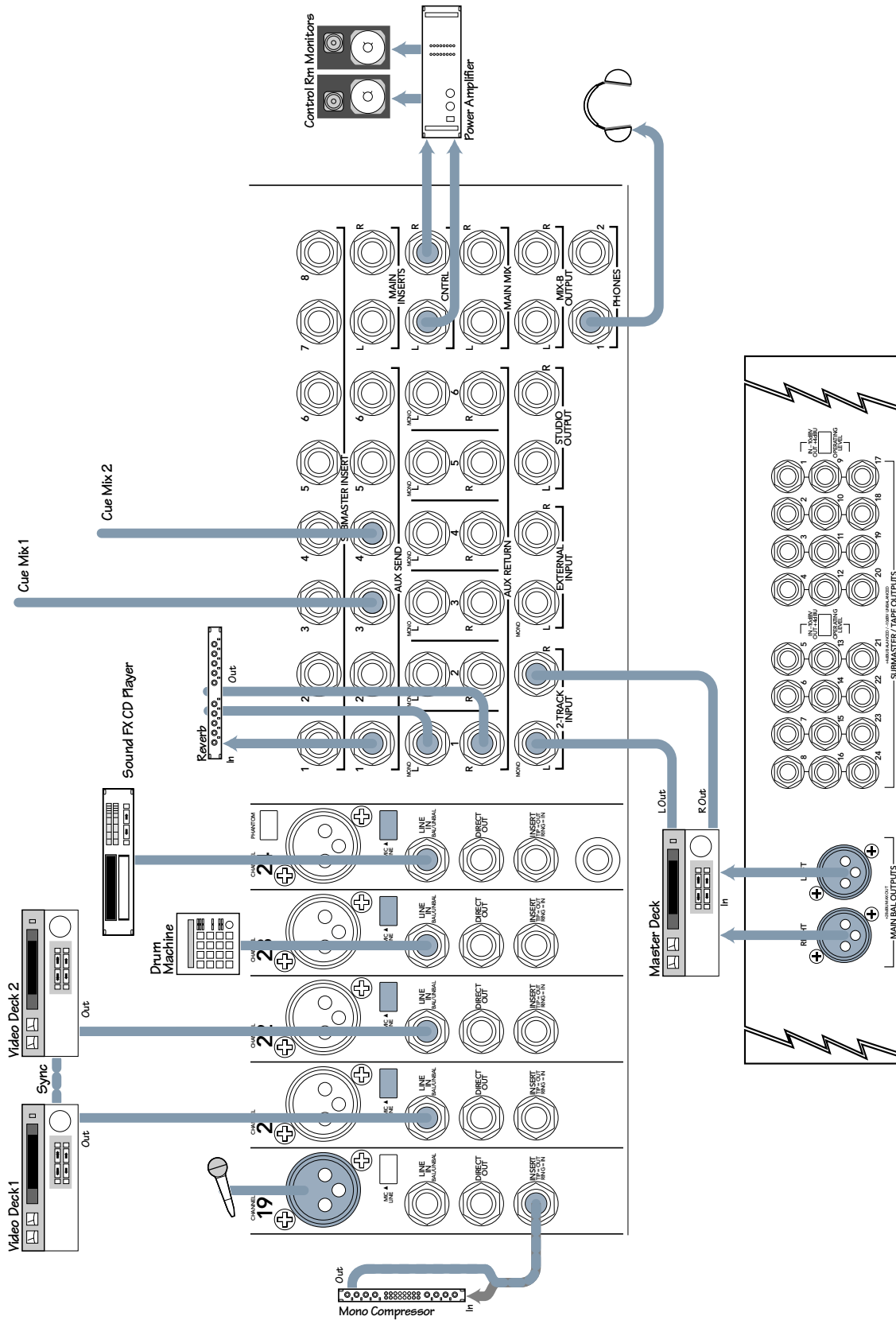

**VIDEO/BROADCAST 1: INPUT/OUTPUT**

Channels 20, 21, 22, 23, and 24 are shown with their respective controls: TRIM, SOLO, AUX SENDS (1-5), EQ (LOW, MID, HI), PAN, LEVEL, MUTE, and faders.

**MACKIE.**  
24x8x2 8-BUS MIXING CONSOLE  
**24.8**

POWER  
SOLO

AUX SENDS  
STEREO AUX RETURNS

MIX B MONITOR  
PHONES 1  
PHONES 2  
MONITOR  
SOLO  
TALKBACK

MAIN OR SOLO LEVEL

Tinted knobs are used in this application

Tinted buttons are pressed IN

**VIDEO/BROADCAST PART 2: THE BOARD**

There are three common points for inserting processing devices in the signal path during mixing:

- In a pre-EQ channel insert point (for one channel only)
- In a sub-master bus insert point (for a subgroup)
- In the L/R Mix insert point (to affect the whole mix)

### Send / Return Devices

Since you're not setting up custom phone cueing while you're mixing, you will normally have all six AUXiliary sends available. Use a couple as your primary reverb sends, perhaps one for a bright plate and the second the same with a slap or pre-delay. That leaves you four for special effects. You can also use the MIX-B outputs or an unused 8-track bus as additional sends. If you only need to put the effect on one channel, you can use the channel Direct Out as a send (and the effects input level as the send level).

Lots of options at this point. Post-fader is almost always the preferred mode for reverb sends. Keep the sends in post unless you don't want the reverb to follow the fader moves. If you want the "wet" sound (lots of reverb), turn the fader down a bit, and turn up the appropriate AUX Send to compensate. Now you have less "dry" signal and more "wet." Dreamy!

Patch the output of the reverb units to the AUX Return inputs, which offer level and pan controls, and assign switches to put your effect where you want it. Notice that each of the six returns has two inputs, for a total of twelve. This allows you to send and return to six stereo effects units and bring all the reverbs and echoes back in.

**Note:** There is no rule against sending on 3 and patching the returns into 5 and 6. If your reverb has stereo inputs, try feeding a mono signal, using just one AUX Send, into its "mono" input. Most reverbs are not true stereo, input-wise. You'll lose nothing and get back an AUX Send.

If you are using a mono effect or only one channel of a stereo effect, using only the Left input jack of a return will place the effect in the center of your mix. If you use the Right jack, the effect will be placed on the right side in your mix. To put the effect on the left side only, patch the return into the Left jack, and place an unwired dummy plug into the Right jack. That will defeat the left-goes-to-center normalling and allow the signal to remain on the left in the mix.

As mentioned above, you can use the AUX Return inputs as additional inputs to the console if you wish. You can also use channel input strips as reverb returns. Simply patch the return into a

Line Input, if you have enough inputs to handle this. (Bonus: you now have console EQ available on your reverb return. Be sure the AUX Send feeding that reverb is turned fully down on the channels being used as reverb returns. If you don't, every dog in the neighborhood will want to hump your leg.)

### Using Subgroups

There will be many times during mixing that you will want to set up subgroups within your mix. A subgroup allows you use just one or two (for stereo) faders on a larger group of tracks (say, drums or horns or background vocals). This makes for easier control (especially if you do not have automation), and also allows you to patch a single (or a matched pair for stereo) EQ or compressor on the set of tracks.

The Mackie 8•Bus console offers you several options using subgroups, depending on the situation.

- To assign channels to a subgroup during mixing, first de-assign the channels you want to subgroup from the L/R MIX. Then choose the bus or pair of buses you'd like to use as a subgroup and reassign the channels to that subgroup. The channel pan controls the selection of buses for a mono subgroup, and the position between buses for a stereo subgroup. For example, if you want a mono subgroup using Bus #1, select 1/2 assign and pan those channels fully left. Now, in the Assign area above the submaster faders, select the combination of L MIX, R MIX and MONO L+R switches that suit you. The L MIX and R MIX switches are upstream of the MONO L+R switches, and must be engaged to make the Mono switches work. Compressors or EQs can be inserted into the Submaster Insert jacks at the top of the Output section.
- Another option is to bypass the bus assign switching above the 8•Bus masters and instead patch the output of the bus(es) back into the inputs of a channel fader or two. Then assign those channels only to the L/R MIX to reinsert the subgroup into the mix. If you have enough input channels, this configuration gives you console EQ and Sends on your subgroup, which may be handy.

### Finding More Inputs: MIX-B to L & R Buses

There are never enough tracks on your recorder, and there are never enough inputs on your console. It's always the case. Your unbridled creativity will find ways to use up everything, whether you are routing the vocals through a pair of Leslie speakers or keying a gated set of

reindeer bells with the snare signal.

The Mackie 8•Bus consoles can't give you the infinite number of channels you dream of, but you can very easily double the number of inputs by using the MIX-B buses.

If you are mixing off tape as we set it up a few pages ago, you have engaged the FLIP switch to put the tape returns into the main channel fader and EQ. The FLIP switch also switches the Line Input to the MIX-B circuitry, and that provides your extra inputs. You can get an AUX Send for the extras using the SOURCE switch in the AUX Send 3/4/5/6 area, and you can SPLIT the EQ if you need to.

Check over in the MIX-B/MONITOR section above the Sub meters and you'll see the MIX-B TO L/R MIX ASSIGN button, which will bring all your MIX-B inputs back into the main mix. Voila! Twice as many inputs!

### Monitoring and Levels

Check your speakers and amplifiers to be sure that they're balanced left-to-right and mounted symmetrically to your mixing position. A 2dB shift in monitor balance will produce a 2dB shift in the opposite direction in your mix.

Also, check your speaker polarity (sometimes inaccurately called phase). This is a basic thing we all know about, but it's amazing the times we've found studio speakers (especially near-field monitors, which are often plugged and unplugged regularly) connected with opposing polarity. You should train your ears to notice out-of-polarity conditions instantly. It's easy to hear (to us it sounds like a combination of not hearing enough bass and feeling like our eyes are slightly crossed), and getting polarity right will save you much grief in mixing.

Remember that you need to mix so that your music or program sounds good on anybody's system. Be sure you have some real-world monitor speakers in addition to the monitors you like so well, and check back and forth frequently. See Section 2 ("Studio Output"), for details on how to use two sets of control room monitors. Check at different monitoring levels, too. A mix that sounds great loud will not necessarily sound good at low volume. Listen at a barely audible level from time to time. You should still be able to hear the essential pieces of your mix.

Also, check your stereo mixes in mono regularly during your mix. Much television and radio is still heard in mono, and your mix has to sound its best both ways.

Take a hint from the film mixers and set your dialog or lead vocals to about 85dB/c at the mixing position. This is a moderate, normal volume; not quiet but definitely not thundering. If you

have a sound pressure meter available you can take a measurement to get a feel for how loud 85dB is. If you don't, run down to Radio Shack and say: "*I want #33-2050 or #32-2055. Here's \$34.99 or \$49.99 plus applicable taxes.*" Every set of self-respecting ears should own one.

This monitoring volume will keep you honest, and keep your mixes balanced for playback. Sure, listen at very low levels, too, and crank it from time to time to remember why you're in this line of work, but stay at the moderate 85dB/c setting most of the time. You will save your hearing and also make better mixes.

### A Word About Automation

There is an optional MIDI automated mixing capability that will be available for the Mackie 8•Bus Series Consoles, so we won't talk about automated mixing here. That's in the manual that comes with the automation components.

For those of you without automation, there is hope. Billions and billions of great mixes have been done on non-automated consoles. Here are a few tips:

- Use subgroups, discussed earlier.
- "Mult" tracks that need drastic EQ or reverb changes to two channels, and alternate between them with the MUTE switches. (*Multing* means connecting one output to two or more inputs by simply paralleling the connections. Some patch bays have paralleled mult strips available. You can also make mult boxes or just use "Y" adapters. Note: Never mult two or more outputs into one input. That's what mixers are for. Only mult one output into two or more inputs. See Appendix A: Connections.)
- Enlist several sets of hands.
- And last, most terrifying, but most powerful and effective: edit between sections of your mix. It would be wise to make two passes of your mix before you chop up your only one.

If you've been wildly editing mixes for years and years, you know what we're talking about. If not, learn to do it. Whether you do it digitally or you use a razor blade, you can fix that tiny detail in an otherwise perfect mix; you can mix a complicated track in sections rather than like a marathon; you can go from 200 instruments to a single whispered vocal and back again in a heartbeat; you can even fix a mix weeks later without losing the original magic—you just remix the one chorus that needs fixing and cut it in.

# SECTION 5: PA AND SOUND REINFORCEMENT APPLICATIONS WITH THE MACKIE 8•BUS CONSOLE

One of Mackie Designs' primary product philosophies is to make its mixers as multi-purpose as possible to make them more affordable. This sounds like a contradiction in terms, but it isn't. By creating consoles JUST for recording and other models JUST for PA, other companies complicate the manufacturing process and reduce their economies of scale.

We designed the 8•Bus Series *from the ground up* for both recording and PA sound reinforcement applications. If you have any doubt as to the durability of your new console, just think of how many smaller Mackie mixers have logged literally millions of air miles on grueling tours (and how many vintage Tapco mixers that Greg Mackie designed are still around and in day-to-day use).

From a features standpoint, Mackie 8•Bus Series consoles are easy to configure for public address and sound reinforcement applications, whether you are mixing the house, stage monitors or both at once. Use the L/R main mix buses and your main L/R outputs as your main signal path.

If you want a headphone cue mix, either patch the Control Room outputs to a suitable headphone amplifier, or select MONITOR as the source for Phones 1 or Phones 2. This will allow you to listen to any source you can select for the Control Room. You can also use the solo buses as headphone cue. If you prefer, you can modify the solo circuits for PFL (Pre-Fade Listen).

## SETUP

Refer to the STEREO LIVE MIX drawings on page 40 and 41.

You should normally use the L/R Mix buses as your Main or House feed. Patch out from the L/R outputs (preferably the balanced XLR outputs) into the input to your amp stack (usually your House graphic equalizer).

Any of the AUX buses can be used to feed a stage monitor mix, but AUX Send 1 and 2 are balanced, so they would be the best choice for several different stage monitor mixes. Set the AUX Sends in each channel to PRE and patch the AUX Send outputs to the appropriate amplifiers.

If you need to provide a simultaneous mix for a stereo recording, use the MIX-B buses as described in MAKING A SIMULTANEOUS RECORDING.

*Text continued on Page 42*



### FOLLOW THIS SENSITIVITY ADJUSTMENT PROCEDURE FOR EACH CHANNEL IN USE:

- Assign signal to channel fader:
  - If channel will be used with a microphone, MIC/LINE switch should be *up* & FLIP switch should be *up*.
  - If channel will be used with line input, MIC/LINE switch should be *down* & FLIP switch should be *up*.
- Set channel strip controls as follows:
  - TRIM pot all the way counterclockwise (+4dB)
  - AUX SEND controls all the way counterclockwise (*off*)
  - EQ switch *up*
  - LOW-CUT switch either *on* or *off* (*on* recommended for mic inputs)
  - Channel fader at UNITY
  - PAN pot hard left or right
  - SOLO switch *down*
- Make appropriate "noise" into the channel input. For example, have a performer play/sing/strike something or someone, etc. at the level they're going to record or perform. Don't just play a single sustained note, but rather, jam away as you would be during recording or performance.
- The channel's -20dB LED should light. The L/R main meters will show the actual internal operating level of soloed signals. Now you will optimize levels.
- Adjust the TRIM control clockwise to get peaks that regularly hit 0dB on the L/R meters.
- If desired (optional):
  - Press the EQ switch *in*.
  - Adjust the channel strip's EQ to about what you will be using during the session.
  - Re-perform Step 5.
- Return the channel strip's SOLO button to its *up* position, and set the PAN pot back where you found it.
- Repeat Steps 1-7 on the next channel that is being used.

PA & SR

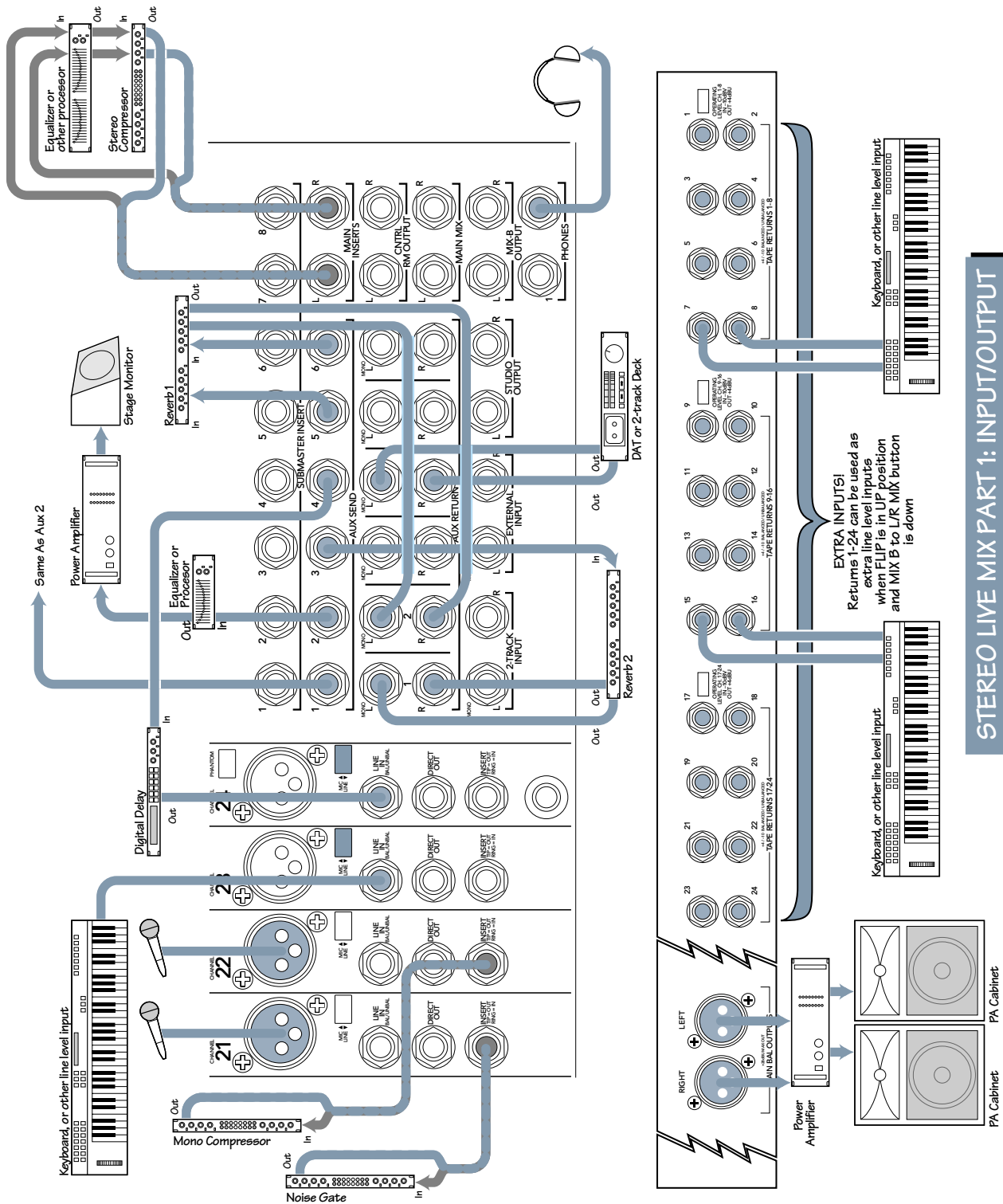

EXTRA INPUTS!  
Returns 1-24 can be used as extra line level inputs when FLIP is in UP position and MIX B to L/R MIX button is down

Keyboard, or other line level input

Keyboard, or other line level input

**STEREO LIVE MIX PART 1: INPUT/OUTPUT**



Typical Drum Mic

Typical Vocal or Instrument Mic

Typical Line (Key) Input

Vox Delay Keys on Tape Input

Drum L

Drum R

Rev 1 L

Rev 1 R

Keys L

Keys R

Rev 2 L

Rev 2 R

# MACKIE

24x8x2 8-BUS MIXING CONSOLE

## 24•8

Tinted knobs are used in this application

Tinted buttons are pressed IN

### STEREO LIVE MIX PART 2: THE BOARD

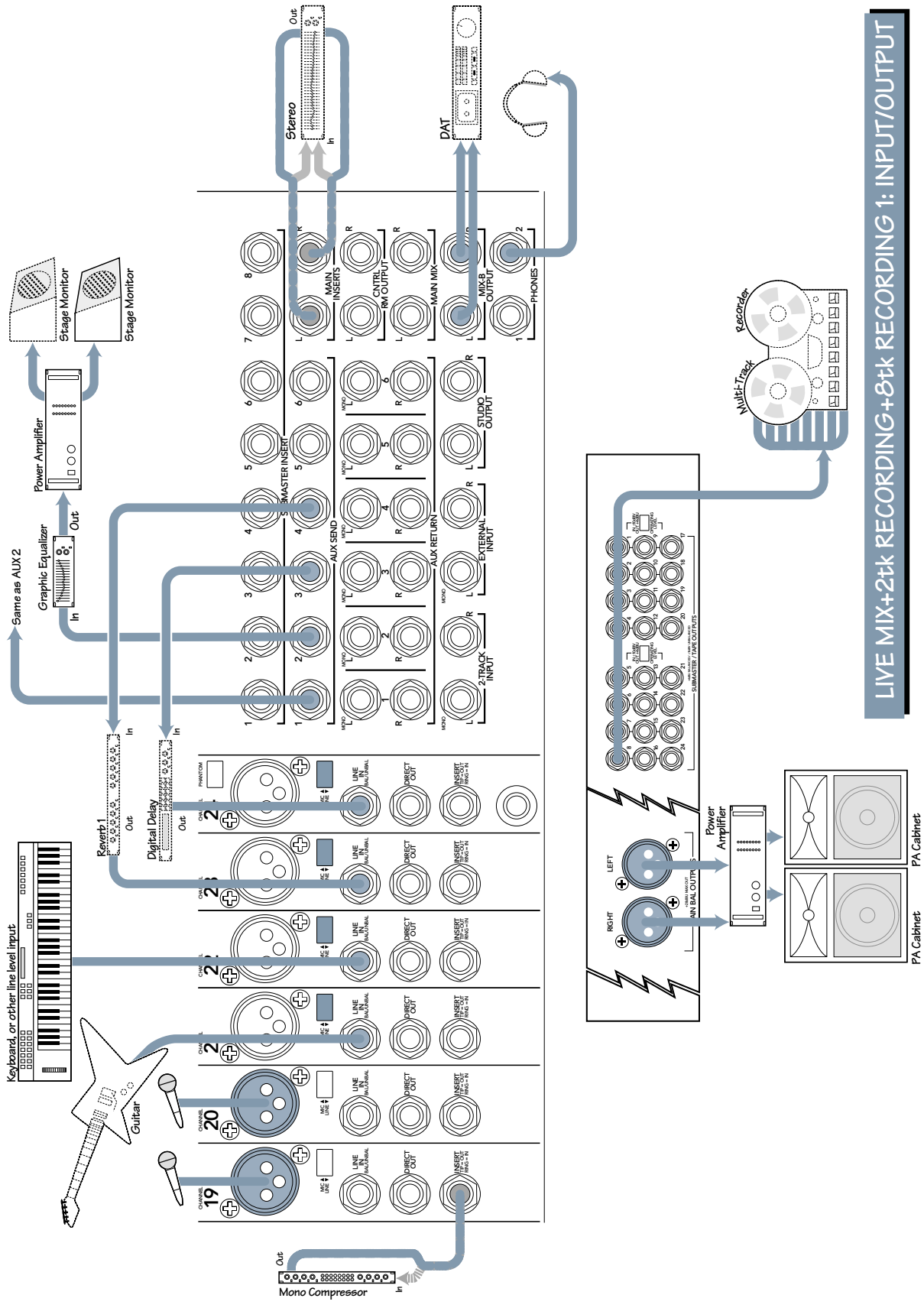

**LIVE MIX+2tk RECORDING+8tk RECORDING 1: INPUT/OUTPUT**

Channel strips 19 through 24, each featuring:

- TRIM knob (0dB to +20dB)
- Level knob (0 to 10)
- ALX (Auxiliary) knob (0 to 10)
- Channel Mixer (MIX) knob (0 to 10)
- EQ knobs (HI, MID, LO) with switches for EQ IN and LOW CUT
- PAN knob (L to R)
- MIX/BUS knob (MIX/BUS to SPLIT)
- MUTE button
- SOLO button
- Level meters (VU meters)

**MACKIE**  
24x8x2 8-BUS MIXING CONSOLE  
**24•8**

POWER

SOLO  ALX SENDS  STEREO AUX RETURNS

1 2 3 4 5 6 7 8

LEVEL BALANCE

PHONES LEVEL MONITOR

MIX B MONITOR PHONES 1 PHONES 2 MONITOR

SOLO TALKBACK

10 20 30 40 50 60 70 80 90 100

L R L R L R L R

1 2 3 4 5 6 7 8

9 10 11 12 13 14 15 16

17 18 19 20 21 22 23 24

MAIN OR SOLO LEVEL

LEFT/RIGHT MIX

Tinted knobs are used in this application

Tinted buttons are pressed IN

LIVE MIX+2tk RECORDING+8tk RECORDING 2: THE BOARD

## HOUSE AND MONITOR MIX TOGETHER

It's a big board, but it's the only one you own. So you find yourself mixing house and monitors all from the same panel.

First, let's take a moment and set everything up sensibly. Just like in a recording session, it's good to group your inputs and sub-mix buses by instruments, stage position or whatever else suits you. Try to keep the drum mics next to each other, the vocals together and so on. Label your cables, color-code your windscreens, lay tape across the arm rest, make a cheat sheet, iron your shorts, give yourself a break. It can be confusing enough mixing a big show without wondering which channel is which.

Using AUX Send-Return loops and inserting outboard gear is the same as when recording, unless you want to use the AUX Sends as independent cue mixes, by engaging the PRE switch for those AUX Sends.

Subgroups can be very helpful in Sound Reinforcement (SR) work. Remember, when you assign a channel to a subgroup, de-assign that channel from the L/R Mix.

### Headphones

If you like to check things out in your phones, and especially if you want to use the 8•Bus solo or (modified) PFL functions as a cue circuit, set your phones up like this:

- Be sure the MONITOR SOURCE switch is set to what you want to listen to (usually L/R Mix, your House feed). You can keep the two Monitor LEVEL controls turned down, though, because you are not feeding amplifiers from the Control Room or Studio outputs.
- Plug your phones into one of the two Phones output jacks; let's say Phones 1. Now select MONITOR on the PHONES 1 SOURCE switch. That should give you L/R Mix bus plus solo. See, the solo bus only feeds the Control Room and Studio Speakers circuits, so we had to poke a few buttons to make it work.

## MAKING A SIMULTANEOUS RECORDING

You're all set up, ready to go, when the band's manager comes up to you with a DAT machine and goes *"The producer wants us to send him a recording of tonight's gig,"* and you go, *"I'll patch it in to the house mix,"* and he goes, *"No, I'd rather get a special mix just for the tape,"* and you roll your eyes and go, *"You should really get a remote truck,"* and he rolls his eyes and goes, *"Here's the tape. Make it good and we might hire you next time."*

Piece of cake.

Refer to the drawings on pages 40 and 41.

MIX-B to the rescue! L/R Mix is your house mix, you will use the AUX buses for stage monitor mix, and MIX-B will provide a stereo recording feed.

Simply depress each of the MIX-B SOURCE switches to CHANNEL, patch the MIX-B outputs into the recorder inputs and set up your recording mix with the MIX-B level controls. To monitor, select MIX-B on the Phones output you're using and route the output of the recorder back into EXTERNAL to check playback.

It's true, there are no meters on the MIX-B buses. Try using the recorder meters. If you can't see them from where you sit, there are a couple of patches you can try to get metering:

- Since you're not using the CONTROL RM or STUDIO outputs, you can use the MONITOR section for metering only. Simply engage only the Mix-B Switch in that section.
- If you have two free submaster buses, patch the MIX-B buses into the submaster insert point. (Push the 1/4" plug only halfway in to the Insert Jack, to the first 'click.' See Appendix A: "Connections" for details.) Set the submaster faders to -6dB to adjust for the insert point gain difference. Now you will have MIX-B levels showing on those two submaster meters, and you can use the SUBMASTER OUTPUTS as feeds to your recorder.
- If you have the optional meter bridge fitted and you have two extra inputs, patch the output of MIX-B into the open channels (either Line In or Tape In, depending on how you have set the global source switch on the meter bridge), set the levels at unity and watch those two channel meters for recording levels. You can now use the two channel's DIRECT OUTS as feeds to your recorder. Make sure all the channel bus and AUX assign switches and controls are off, so you don't accidentally assign your signal back into the mix. Also, this way you could add a little EQ or compression via the channel inserts.
- In either of the above cases, you may want to keep the extra circuitry out of your recording signal path. If so, just mult the MIX-B outputs to both your recorder and to the patch point for metering.

### HOUSE MIX ONLY or MONITOR MIX ONLY

Much easier than both at once, but requires two mixers. Simply split the mics, set one mixer up for house (on the L/R Mix buses, as above)

and the other one up for stage monitor. If you need to do some combination of house/recorder feed or vocal/drum/keyboard monitors, divide the functions up between L/R Mix, AUX buses and MIX-B buses as described above.

### Mic Splitters

If you are using one mixing console for your main or house mix and another for stage monitors, the best way to distribute the microphone signals to both consoles is by using a good quality mic splitter box. Splitters use transformers specially designed to split the signal and keep the impedance match correct while rejecting noise and preventing ground loops. You can get splitters with as many input channels as you need, each with from two to five outputs for each mic input.

Mic splitter transformers are expensive, but are well worth the investment. They will provide the most consistent trouble-free performance with multiple mixers.

If you need to split your inputs but do not have splitter transformers, you can make a special harness of cables to split out of the Mackie channel insert. This technique is not always as flexible or ground-loop-proof as splitter transformers, but is much less expensive. See Figure 11 in Appendix A: "Connections."

### FINDING MORE INPUTS

You bought a 32-channel mixer and you still don't have enough inputs. Well, before you go to the bank again, remember that the Mackie 8•Bus Series has some options for you:

- You can get up to 32 additional line inputs using the Tape In to MIX-B path. You can even split the EQ and Aux Buses to the MIX-B inputs if you want. Then assign Mix-B to L/R Mix.
- Any unused AUX returns (there are 12 inputs) can be used as additional line inputs.
- In a pinch, you can use the eight Submaster's inserts providing the sub is currently unused (no channels assigned to it). Use a 1/4" TS cable and plug in only to the first click. Signals entering here will be kicked up by +6dB.

# APPENDIX A: Connections

## "XLR" CONNECTORS

Mackie mixers use 3-pin female "XLR" connectors on all microphone inputs, with pin 1 wired to the grounded shield, pin 2 wired to the "hot" (positive polarity) side of the audio signal and pin 3 wired to the "cold" (negative polarity) side of the signal (Figure 7).

Use a male "XLR"-type connector, usually found on the nether end of what is called a "mic cable," to connect to these inputs.

Mackie occasionally uses 3-pin male "XLRs" for balanced line outputs. The Main L/R Outs on the 8•Bus, for example, are available on XLRs. These are also wired pin 1 ground, pin 2 high and pin 3 low.

## 1/4" TRS PHONE PLUGS AND JACKS

"TRS" stands for Tip-Ring-Sleeve, the three connections available on a "stereo" 1/4" phone jack or plug (Figure 8). TRS jacks and plugs are used in several different applications:

- Stereo headphones, and rarely, stereo microphones and stereo line connections. When wired for stereo, a 1/4" TRS jack or plug is connected tip to left, ring to right and sleeve to ground. Mackie mixers do not directly accept 1-plug-type stereo microphones. They must be separated into a left cord and a right cord that are plugged into two channels.
- Balanced mono circuits. When wired as a balanced connector, a 1/4" TRS jack or plug is connected tip to signal high, ring to signal low, and sleeve to ground.
- Unbalanced Send/Return circuits. When

wired as send/return connector, a 1/4" TRS jack or plug is connected tip to signal send (output from mixer), ring to signal return (input back into mixer), and sleeve to ground.

## 1/4" TS PHONE PLUGS AND JACKS

"TS" stands for Tip-Sleeve, the two connections available on a "mono" 1/4" phone jack or

plug (Figure 9). TS jacks and plugs are used in many different applications, always unbalanced. The tip is connected to the audio signal and the sleeve to ground. Some examples:

- Unbalanced microphones
- Electric guitars and electronic instruments
- Unbalanced line-level connections

## SWITCHED 1/4" PHONE JACKS

1/4" phone jacks can incorporate switches that are activated by inserting the plug. These switches may open an insert loop in a circuit, change the input routing of the signal or serve other functions. The Mackie 8•Bus Series uses switches in the channel and bus Insert Jacks, and in the mono/stereo AUX Return Jacks. See Special Mackie Connections on page 45. We also use these switches to ground the inputs of most line level ins/outs when nothing is plugged into them.

ADD-ONS  
SPECS  
ETC.

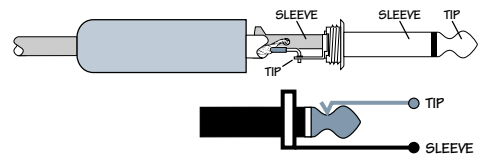
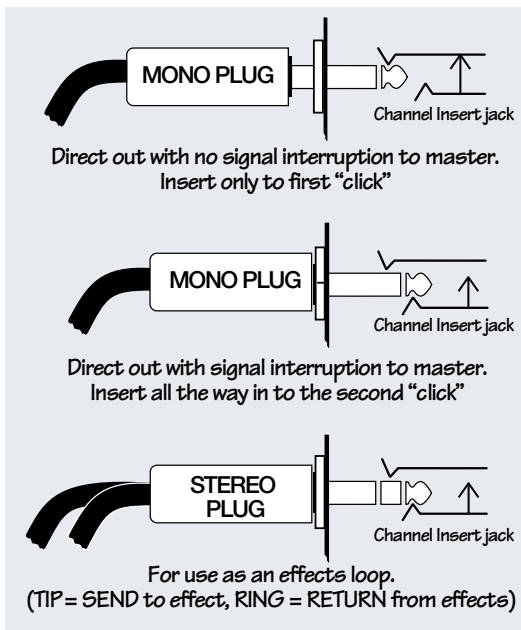

Figure 9: TS connectors (Plugs Biconductor)

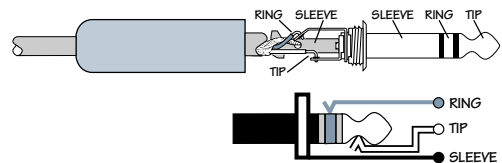

Figure 8: TRS connectors (Plugs Triconductor)

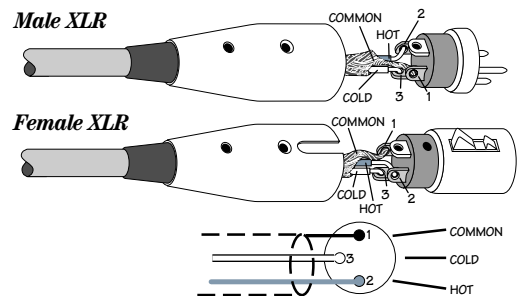
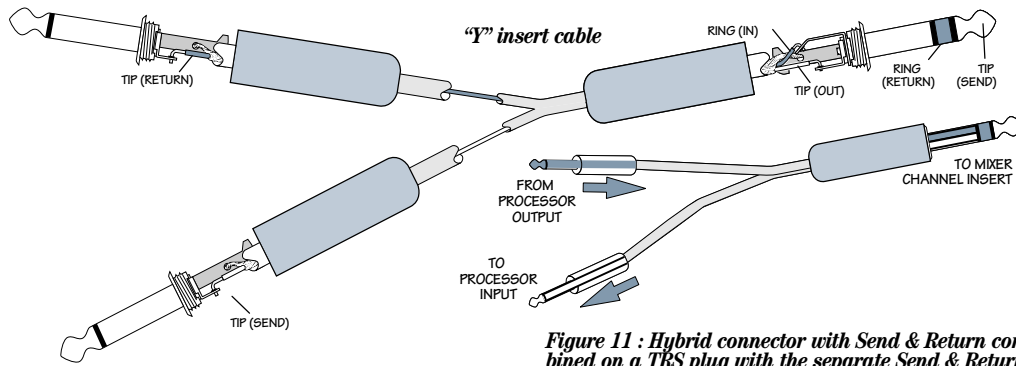

Figure 7 (above): XLR connectors (Exlaris Triptipus)

Figure 10 (below): RCA connector (Plugs Amateuris)





**Figure 11 : Hybrid connector with Send & Return combined on a TRS plug with the separate Send & Return on the TS plug ends (Plugis Insertis Hybridus)**

In most cases, the plug must be inserted fully to activate the switch. Mackie takes advantage of this in some circuits, specifying circumstances where you are only to partially insert the plug. Once again, see Special Mackie Connections, on the next page.

## RCA PLUGS AND JACKS

RCA “phono” plugs and jacks are often used in home stereo and video equipment and in many other applications (Figure 10). They are unbalanced, and electrically identical to a 1/4" TS phone plug or jack. Connect the signal to the center post and the ground or shield to the surrounding “basket.” There are no RCA jacks on the Mackie 8•Bus Series Mixing Consoles. Adapters to convert an RCA male plug to male 1/4" TS plug are available at any electronic shop, like Radio Shack.

## UNBALANCING A LINE

In most studios, there is a mix of balanced and unbalanced inputs and outputs on the various pieces of equipment. This usually will not be a problem in making connections.

- When connecting a balanced output to an unbalanced input, be sure the signal high connections at each end are wired together, and the balanced signal low goes to the ground connection at the unbalanced input. In most cases, the balanced ground will also be connected to the ground at the unbalanced input. If there are hum or radio frequency ground-loop problems, this connection may be left disconnected at the unbalanced end.
- When connecting an unbalanced output to a balanced input, be sure that the signal high connections at each end are wired together. The unbalanced ground connection should be wired to the low and the ground connections of the balanced input. If there are ground-loop problems, try connecting the

unbalanced ground connection only to the input low connection, and leaving the input ground connection disconnected.

In some cases, you will have to make up special adapters to interconnect your equipment. For example, you may need a balanced XLR female connected to an unbalanced 1/4" TS phone plug.

## SPECIAL MACKIE CONNECTIONS

The balanced-to-unbalanced connection has been anticipated in the wiring of the Mackie 8•Bus Series jacks. A 1/4" TS plug inserted into a 1/4" TRS balanced input, for example, will automatically unbalance the input and make all the right connections. Conversely, a 1/4" TRS plug inserted into a 1/4" unbalanced input will automatically tie the ring (low) to ground.

### TRS Send/Return Insert Jacks

The Insert Jacks on both the 8•Bus input channels and on the Submaster and Main Mix buses are the three-conductor, TRS type 1/4" phone. They are unbalanced, but have both the mixer output (send) and the mixer input (return) signals in one connector (Figure 11 above).

The sleeve is the common ground for both signals. The send from the mixer to the external unit is carried on the tip, and the return from the external unit to the mixer is on the ring.

### Using the Send Only on an Insert Jack

If you insert a TS (mono) 1/4" plug only partially (to the first “click”) into an 8•Bus Series Insert Jack, the plug will not activate the jack switch and will not open the insert loop in the circuit.

This allows you to borrow the channel or bus signal at that point in the circuit, without interrupting normal operation. Note: Do not overload or short-circuit the signal you are tapping from the mixer. That will affect the internal signal in the 8•Bus Series.

ADD-ONS  
SPECS  
ETC.

*Figure 12: “Y”cord (a.k.a. MULT) for splitting signal (Plugs Makus Doublis). Note that all three plugs are the same — either TS (shown) or TRS. Don’t confuse this “off the shelf” connector with hybrid insert plugs as shown in Figure 11.*

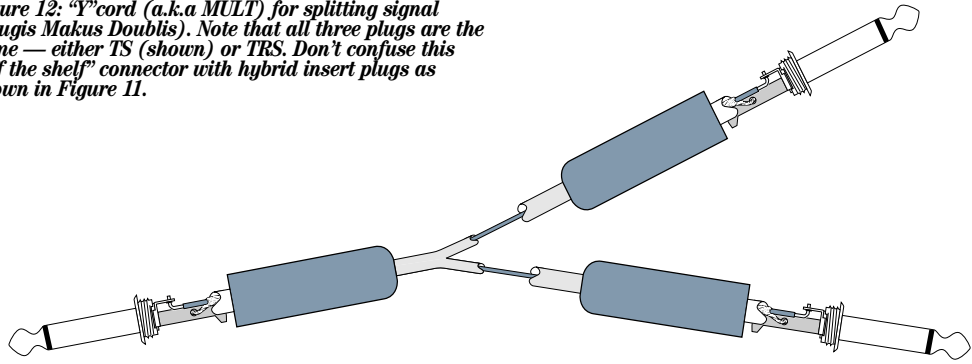

### Using the Return Only on Sub and Main Insert Jacks

If you insert a TS (mono) 1/4" plug only partially (to the first “click”) into an 8•Bus Series Submaster or Main insert jack, the plug will not activate the jack switch and will not open the insert loop in the circuit.

This allows you to insert signal into the submaster or main at that point in the circuit. Note: Only unused buses can be used in this manner. Do not insert signal into a bus with signal on it, or unpredictable results may occur.

### MACKIE AUX RETURNS: Mono, Stereo, Whatever

The Stereo AUX Returns are a fine example of the Mackie philosophy (which we just made up) of Maximum Flexibility with Minimum Headache. The returns will automatically be mono or stereo, depending upon what you plug into the Return Jacks. Here’s how it works:

A mono return should be patched into the Return Jack labeled LEFT (MONO). The signal will be routed to both the left and right sides of the return circuit, and will show up in the center in any stereo pair of buses you assign it to.

A stereo return, having two return plugs, should be patched into the LEFT (MONO) and the RIGHT Return Jacks. A jack switch in the RIGHT Jack will disable the mono function, and the returns will show up in stereo.

### MULTS AND “Y”s

A mult or “Y” connector allows you to route one output to two or more inputs by simply providing parallel wiring connections. You can make Ys and mults for both unbalanced and balanced circuits. See Figure 12 for an example. Remember: Only mult or “Y” an output into several inputs. If you need to combine several outputs into one input, you must use a mixer, not a mult or a “Y.”

ADD-ONS  
SPECS  
ETC.



# APPENDIX B: Options, Add-Ons and Extra Stuff

## OPTIONS

### Meter Bridge

You can order an optional Mackie meter bridge for any 8•Bus Series console. The meter bridge extends across the width of the mixer and provides a 12-LED bar-graph meter (identical to the 8 submaster bus meters) for each channel strip. The meters can be globally switched, metering either the Tape Return signals to the mixer, post-tape-in level switch (for watching multitrack source and tape levels) or the post-fader/post-mute switch channel signals (handy for live sound mixing).

### The Mackie Sidecar

The Sidecar provides eleven rack spaces for patchbays, the Mackie power supply, etc. At the back is a cable storage rack for organizing connection cords.

### Un-Cigarette Lighter

An automobile-type cigarette lighter can be mounted on the front panel of your mixer, but NOT CONNECTED! What a joke for your smoking friends!

### Mixing Shoes

The Mackie Kotoor Coollectshun of fine wearables includes our way-cool, lightweight Mixing Shoes. They're designed for long hours and superior traction so that a little slip never ruins your mix.

Insist that everyone in the control room wear Mackie Brand Mixing Shoes. They're available in Rock, Soft Rock, Metal, Alternative, Country, Jazz, Gospel, Insufferable Audiophile and special spiked-steel-toe Producer/Client-Booters.

ADD-ONS  
SPECS  
ETC.

# APPENDIX C: Specifications

## 24•8 and 32•8 Specifications

Because Mackie Designs is always trying to improve its products with new components and manufacturing methods, these specifications may change at any time. But you can bet your left monitor speaker that the specs won't be any worse than they are here.

ADD-ONS  
SPECS  
ETC.

**Noise.** (Measured 20Hz to 20kHz bandwidth, Tape Returns selected, no EQ, Channel Pans alternating L/R, L/R. "Faders up" refers to Unity gain, 0dBu position.)

**Main L/R Output Noise.** Master fader down, -101dBu; master fader up/no ch.'s assigned, -95dBu; master fader up/24 chs. assigned, -90dBu; master fader up/24 chs. assigned, ch. faders up, -86dBu; +4dB operating level S/N ratio, -90dBu

**Submaster Output Noise.** Master fader down, -99dBu; master fader up/no ch.'s assigned, -96dBu; master fader up/24 chs. assigned, -90dBu; master fader up/24 chs. assigned, ch. faders up, -86dBu; +4dB operating level S/N ratio, 90dB

**Total Harmonic Distortion.** (1kHz @14dBu measured 20Hz-20kHz, mic input, 1 channel assigned). Direct output, 0.0013% typical; L/R Mix output, 0.0014% typical; Submaster output, 0.0015% typical

**Crosstalk.** (1kHz measured relative to 0dBu, measured 20Hz to 20kHz.) Line In to Adjacent Channel, -91dBu; L/R mix output w/channel down, -95dBu; submaster output w/channel down, -96dBu; L/R mix output w/channel muted,

-95dBu; submaster output w/channel muted, -96dBu; L/R mix output w/channel unassigned, -91dBu; submaster output w/channel unassigned, -95dBu; L/R mix output w/adjacent channel assigned, -92dBu; submaster output w/adjacent channel assigned, -94dBu; L/R mix output pan pot attenuation, -87dBu; submaster output pan pot attenuation, -87dBu

**Frequency Response.** +0dB/-1dB, any input to any output 20Hz to 60kHz; +0dB/-3dB, any input to any output, 10Hz to 120kHz

**E.I.N.** Mic input (150Ω termination, 20Hz-20kHz) -129.5dBm

**C.M.R.R.** Mic input, max gain @1kHz, -83dBu; line input, minimum gain @1kHz, -45dBu; tape input, no gain @1kHz, -45dBu

**Maximum Levels.** Mic input, +14dBu; all other inputs, +22dBu; L/R Mix balanced output, +28dBu, all other outputs, +22dBu

**Impedances.** Microphone input, 1.5 kΩ; channel insert return, 2.5 kΩ; all other inputs, 10 kΩ or greater; all outputs, 120Ω

**Equalization.** Hi Mid, full parametric, +/-15dB freq. sweep from 500Hz-18kHz, bandwidth (Q) variable from 1/12 octave to 3 octaves; Lo Mid, swept, 45Hz-3kHz +/-15dB; Hi, shelving, 12kHz +/-15dB; Lo, shelving 80Hz +/-15dB; Lo Cut (HPF) 75Hz, 18dB/octave (Tchebehev)

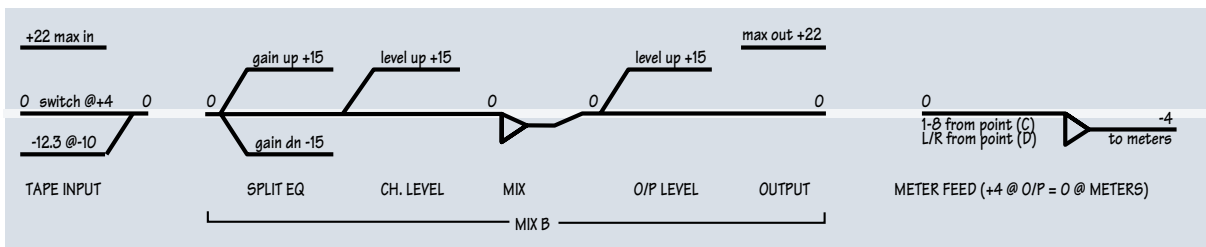
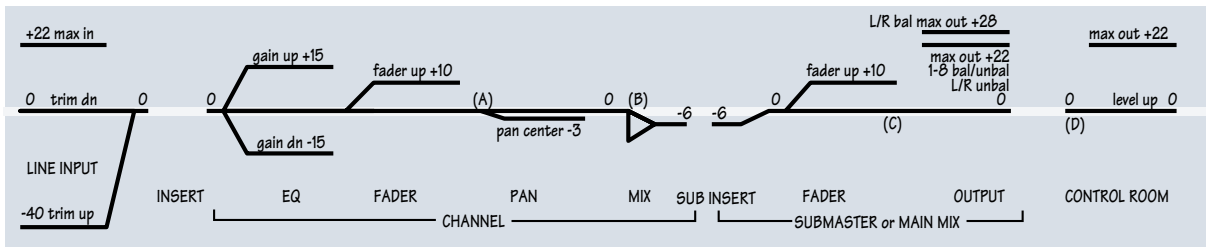

**MACKIE.24•8**  
**24x8x2 8-BUS MIXING CONSOLE**  
 V.15 6/4/95 ©1995 MACKIE DESIGNS INC.

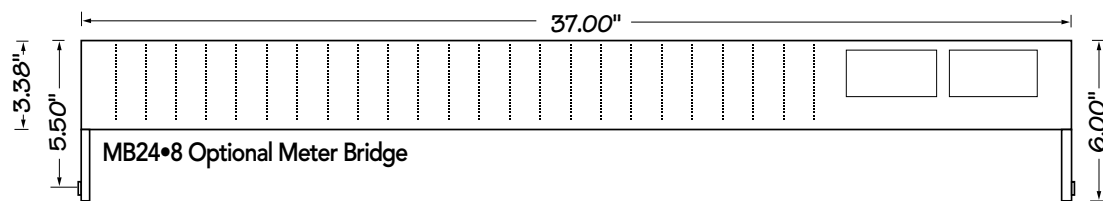
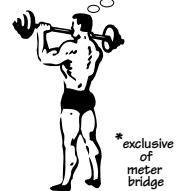
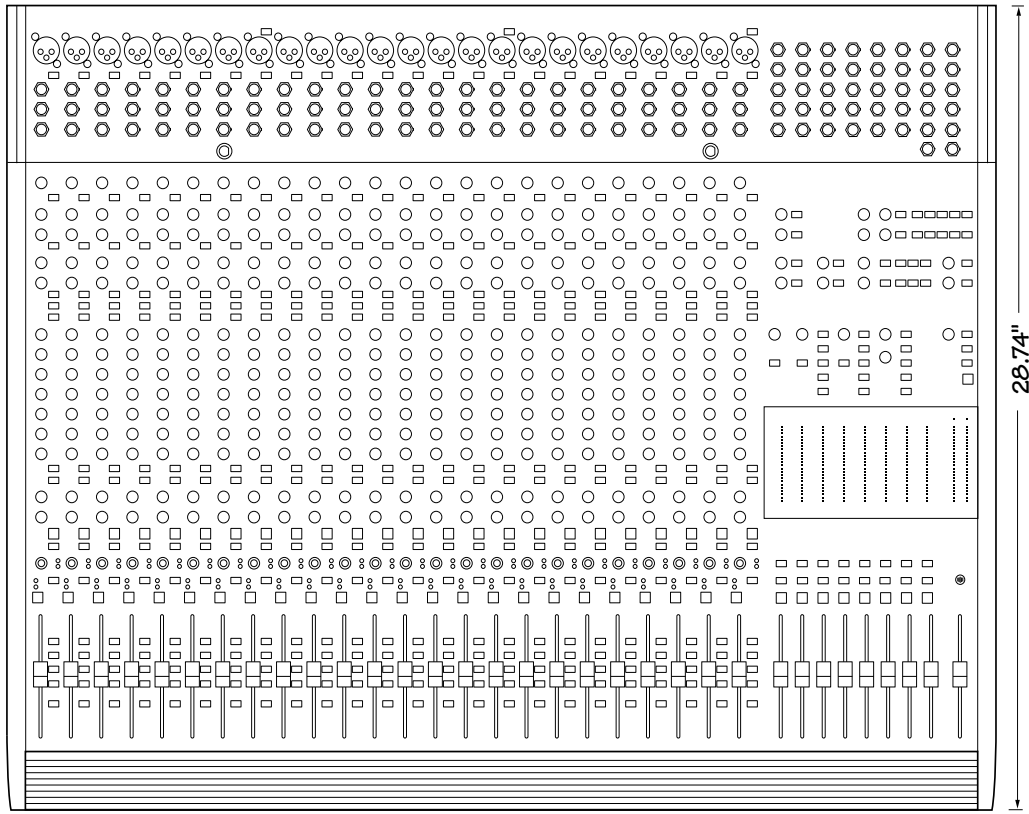
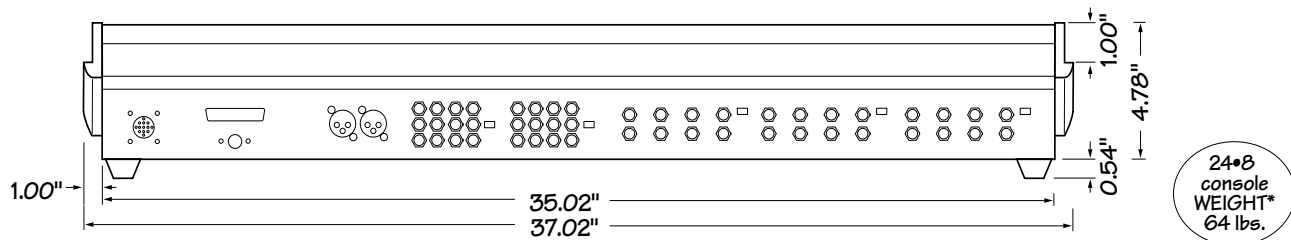
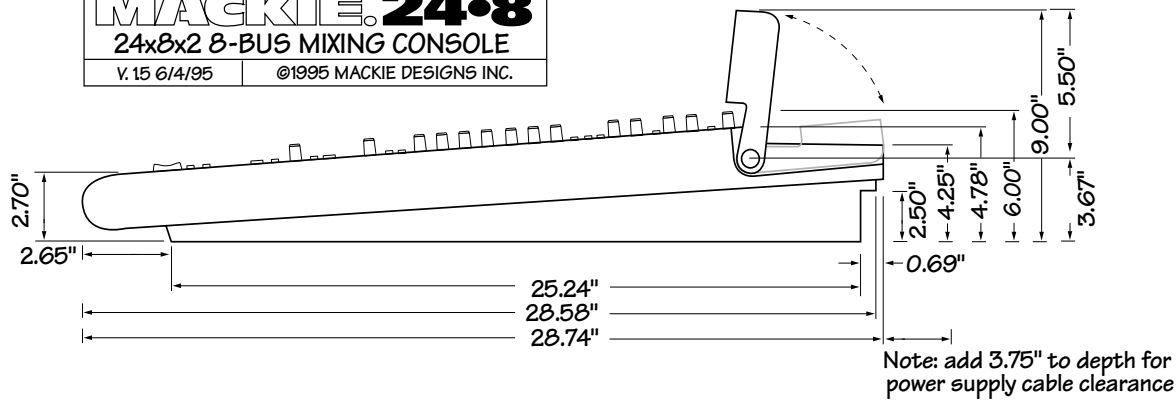

**MACKIE 32•8**  
**32x8x2 8-BUS MIXING CONSOLE**  
 V. 15 6/4/95 ©1994 MACKIE DESIGNS INC.

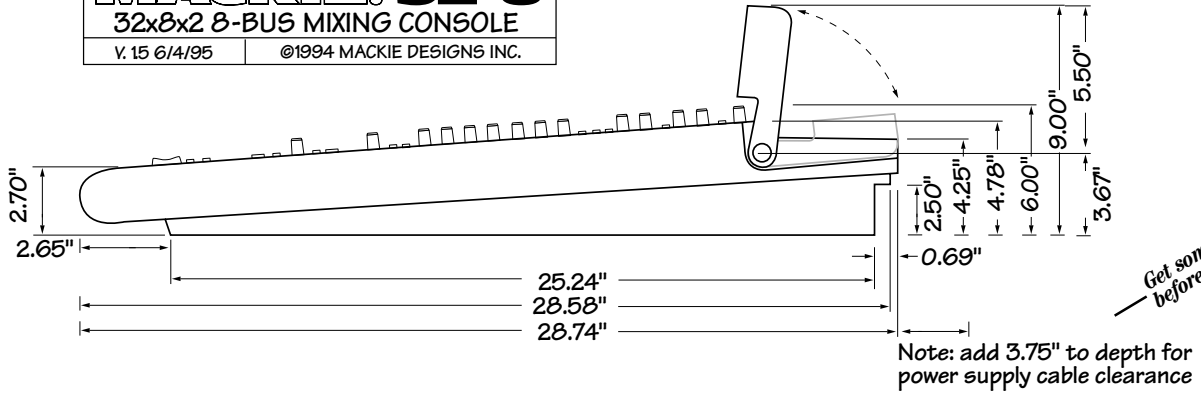

Get some help before lifting this one...

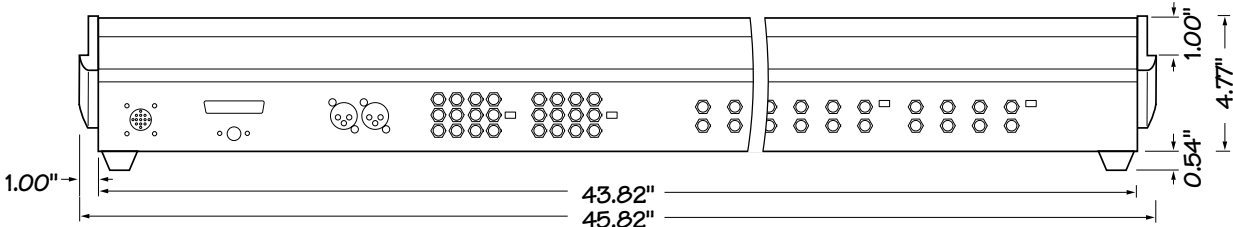

32•8 console WEIGHT\* 78 lbs.



\*exclusive of meter bridge

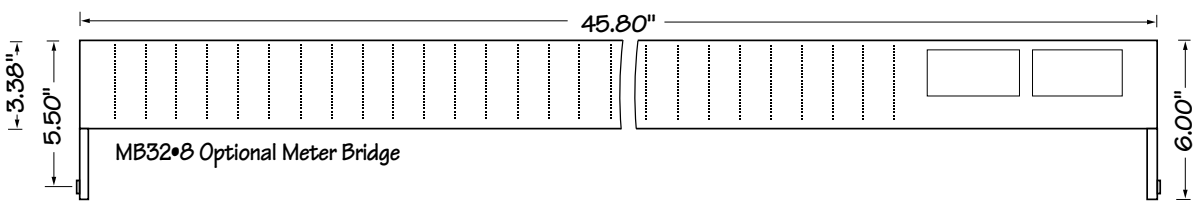
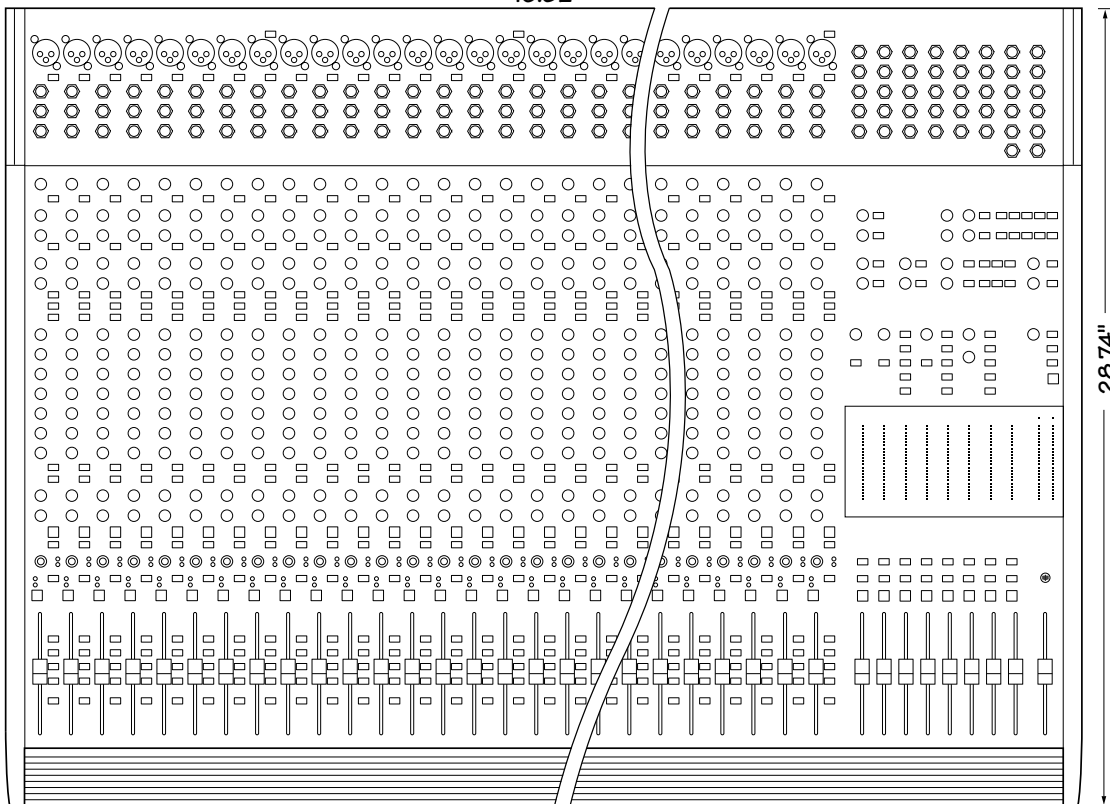

**MACKIE.**  
**8•BUS SIDE CAR RACK**  
 V. 1.1 6/5/95 ©1995 MACKIE DESIGNS INC.

Side Car  
 WEIGHT\*  
 45 lbs.

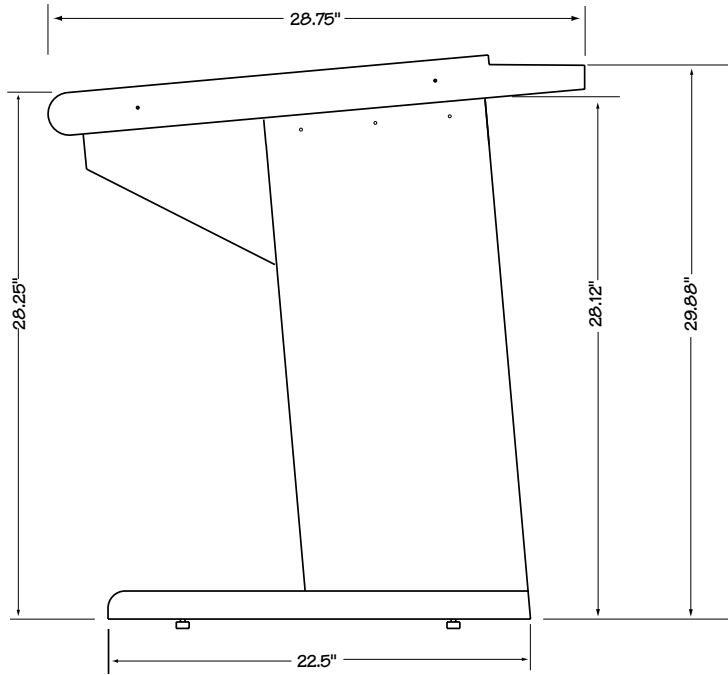

SIDE VIEW

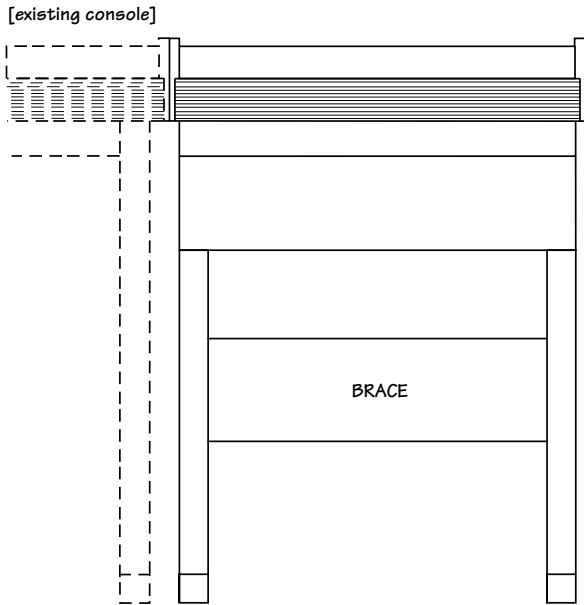

FRONT VIEW

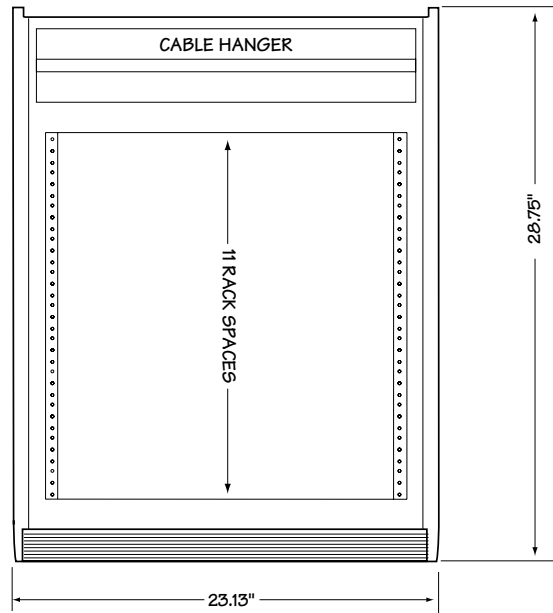

TOP VIEW

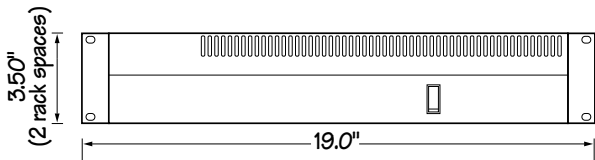

**MACKIE.**  
**220-WATT POWER SUPPLY FOR**  
**8•BUS CONSOLES & EXPANDER**  
 V. 12 4/4/94 ©1994 MACKIE DESIGNS INC.

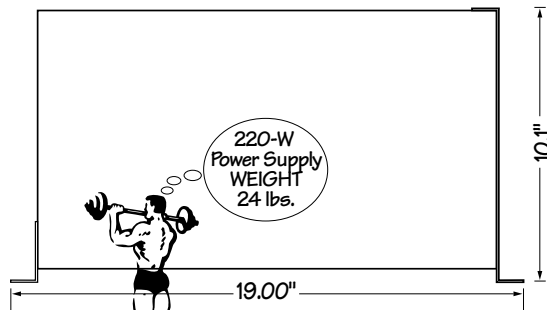

# 8•BUS CONSOLE BLOCK DIAGRAM

Rev. 5.1- 6/6/95 ©1995 Mackie Designs

OPTIONAL 24•E  
24-CHANNEL MACKIE 8•BUS  
EXPANDER CONSOLE

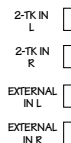
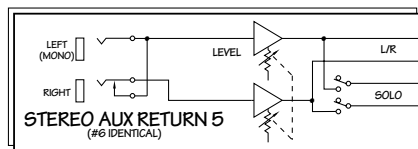
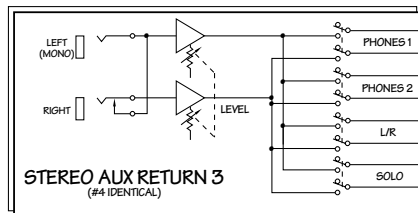
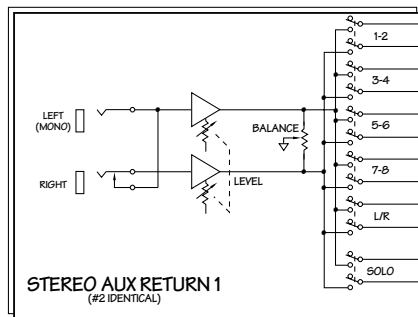
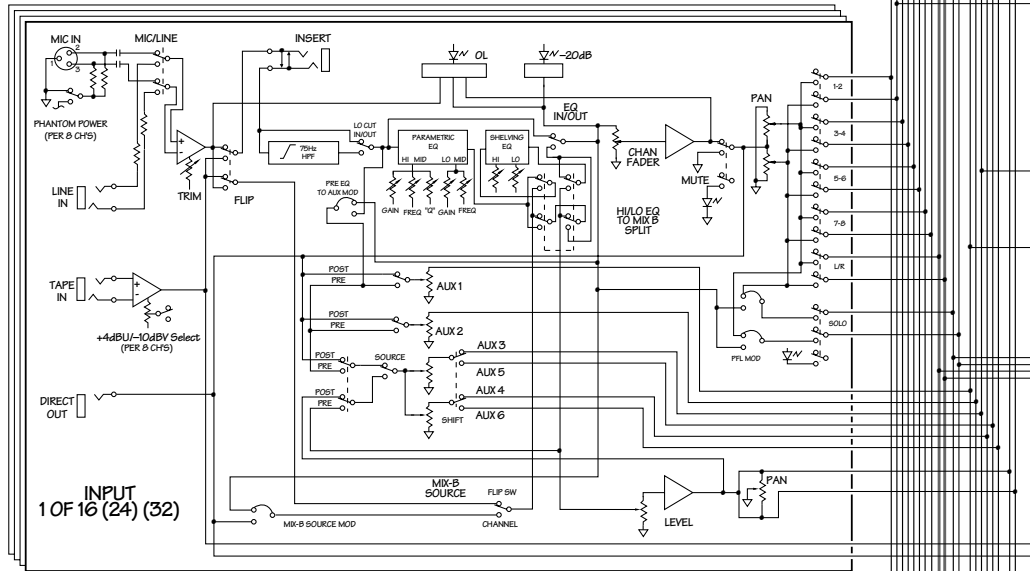

To on-ramp #257  
of the Santa Ana Freeway



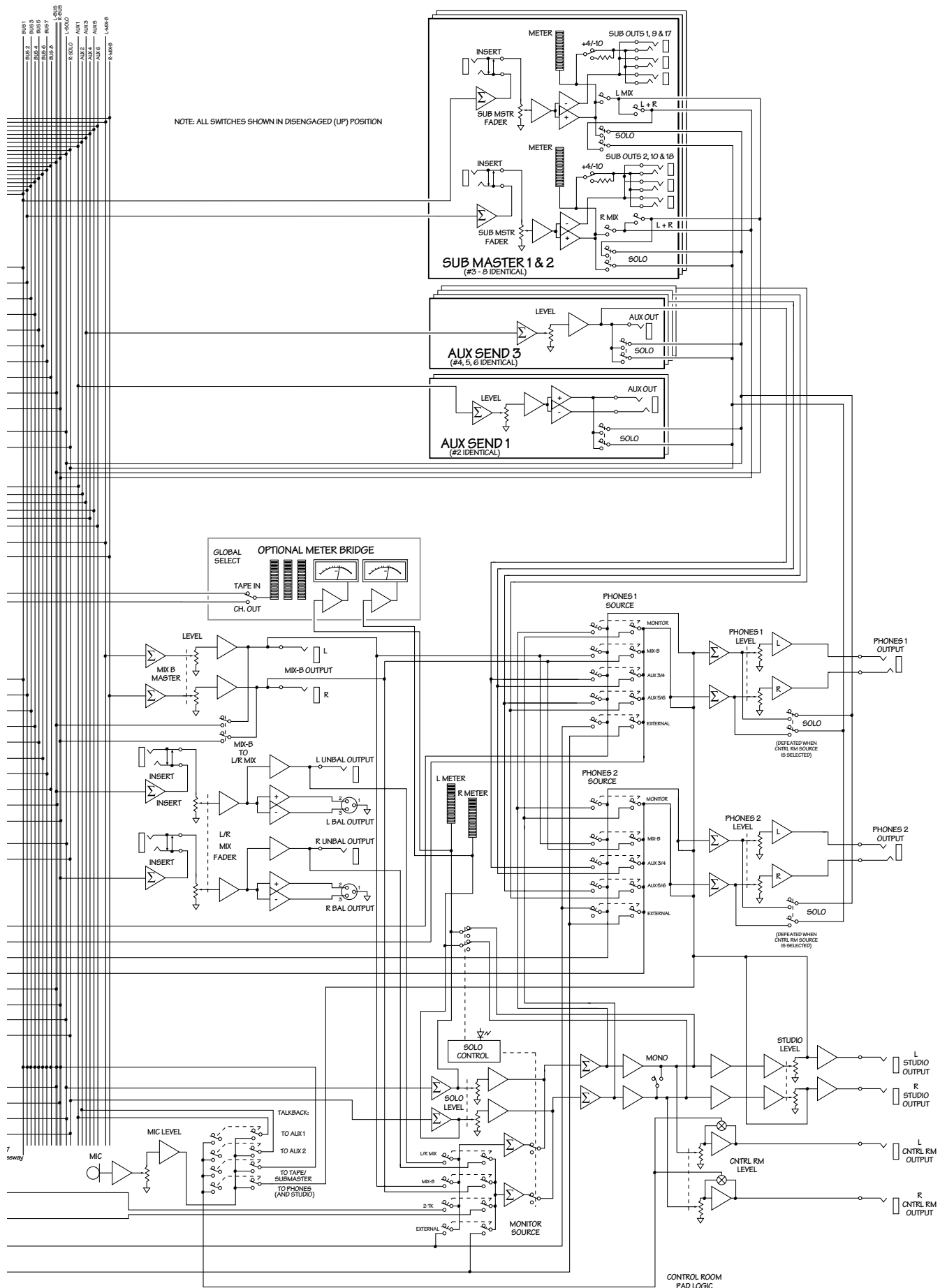

NOTE: ALL SWITCHES SHOWN IN DISENGAGED (UP) POSITION

# SERVICE



## PLEASE! SAVE THE SHIPPING BOX!

Yes, we know it's only slightly smaller than a doublewide mobile home, but you will need the entire carton and internal foam if your console ever needs service at some time in the future.

If your kids make the box into a fort and cut holes in it — or if you stuff it in the dumpster of the fast-food place next door to your studio, we may have to sell and ship you another packing box later on.

Don't end up buying an empty box!

Mackie mixing systems are notoriously bullet-proof and reliable. But, hey...stuff happens. Any electronic product with as many parts as an 8•Bus console can occasionally have a minor casualty somewhere inside.

And even if we *could* build our products to never break, there are those acts of nature that tend to visit consoles on occasion: spilled coffee, toppling monitors, etc. This section covers how to get your Mackie 8•Bus console healthy again.

## Troubleshooting

It benefits everyone if you do a bit of basic troubleshooting first, to determine whether or not your board is really malfunctioning. First, it saves you downtime and embarrassment if, for example, you discover that the only thing wrong is an unplugged power supply. Second, it will save money. If you ship your console to Mackie or an Authorized Service Center and they can't duplicate the problem, you may get slapped with a service charge (plus shipping costs).

We could write a whole manual on troubleshooting, but our main point is that there are a few obvious things you can easily look for:

**Power connections.** This sounds insultingly simple, but if the whole board is completely dead, it's time to make sure that the power cable is connected, that the console power supply is turned on, plugged in, etc. You may also need to unplug the AC cord from the power supply to gain access to the little "drawer" (in the AC receptacle) in order to check the AC fuse.

**Intermittent signal problems.** Faulty plugs and cables are often the culprits. A TRS plug can sit in a socket for months doing its job and then suddenly decide (based on the phase of the moon and barometric pressure) to short or stop conducting. If you're having trouble with an individual channel, send or return, for gosh sakes swap cables before sending the board in for service.

**Check switch positions.** Multi-bus consoles are pretty complicated. Switches like MIC/LINE, FLIP and EQ SPLIT can give the impression that something isn't working right, if you're not expecting them to be engaged.

*Finally*, it doesn't hurt to call our Technical Support Department at 800/258-6883 (8AM-4:30PM Pacific time) to see if they have any ideas as to what might be wrong.

**Note:** For best results have unit in front of you (or close by).

## How to get Mackie service

Service and repairs of Mackie 8•Bus products are to be performed only :

- A. at our factory *OR*
- B. at an Authorized Mackie 8•Bus Warranty Service Center

**Unauthorized service, repairs or modification will void your warranty.**

## To obtain factory service:

1. Call Mackie Technical Support at 800/258-6883, 8AM to 4:30PM Monday through Friday (Pacific Time) to get a Return Authorization (RA).



**Please have your serial numbers ready. [Products returned without an RA number will be refused.]**

2. Pack the 8•Bus Series Console and Power Supply in their original shipping cartons. If you do not have the carton, request one when you get your RA number, and we'll send a shipping carton out promptly. There may be a charge for this gigantic bale of white cardboard, however — we put those huge "SAVE THE BOX" warnings in this manual for a reason. Make sure that you encase the console in its plastic wrapper and insert all the foam blocks to properly protect the console.
3. In some cases, the problem might be the console *OR* the power supply. Just to be sure, send both.



4. When packing the Console, include:
  - A. A note explaining exactly how to duplicate the problem. (If we cannot duplicate the problem at the Mackie Factory or establish the starting date of your Limited Warranty, we may, at our option, charge for service time.)
  - B. A copy of the sales receipt with price and date showing.
  - C. Your return street address (no P.O. boxes or route numbers, please!).
5. **Write the RA number plainly on the outside of the shipping carton.**
6. Ship the product in its original shipping carton, freight prepaid to:

**Mackie Designs**  
**16220 Wood-Red Road N.E.**  
**Woodinville, WA 98072 USA**

#### **To obtain service from an Authorized Mackie Service Center:**

1. Call Mackie Designs at 800/258-6883, 8AM to 5PM Monday through Friday (Pacific time) to obtain an RA number and the name and address of your nearest Mackie Authorized 8•Bus Service Center.
2. Make sure that you have a copy of your 8•Bus Series Console sales receipt from the store where you bought the board. It is necessary to establish purchase date and thus determine whether or not your 8•Bus Series Console is still under warranty. If you can't find it, the Authorized Service Center may charge you for repairs even if your 8•Bus Series Console is still covered by Mackie's 1-Year Limited Warranty.
3. Make sure that the problem can be duplicated. If you bring or ship your 8•Bus Series Console to an Authorized Service Center and they can't find anything wrong with it, you may be charged a service fee, plus shipping.
4. If the Mackie Authorized Service Center is located in another city, pack the 8•Bus Series Console and Power Supply in their original shipping cartons (**be sure to write the RA number plainly on the outside of the shipping carton**).



SERVICE

# TRACK SHEETS

Some of you folks are meticulous and do things like keep your checkbook reconciled and cross-file each tape. For you we have included master Track and Master sheets. They are intended for duplication purposes (unless you bought this console just to do one session).



**ON  
FOLLOWING  
PAGES**

# SESSION

DATE \_\_\_ / \_\_\_ / \_\_\_

TRACKS \_\_\_ thru \_\_\_

## TRACK COMMENTS:

Tk. \_\_\_

Tk. \_\_\_

Tk. \_\_\_

Tk. \_\_\_

Tk. \_\_\_

Tk. \_\_\_

Tk. \_\_\_

Tk. \_\_\_

CH. _____	CH. _____	CH. _____	CH. _____	CH. _____	CH. _____	CH. _____	CH. _____
CH. _____	CH. _____	CH. _____	CH. _____	CH. _____	CH. _____	CH. _____	CH. _____

This is the back of a master track sheet,  
which came in the Mackie 8•Bus console  
manual.

If you find this sheet in a copy machine,  
please return it to the engineer/owner of  
the console.

If you find this sheet in the back of a  
gloomy tavern, buy it a cold one.

# SESSION

DATE \_\_\_/\_\_\_/\_\_\_

## BUS COMMENTS:

Bus \_\_\_\_\_

Bus \_\_\_\_\_

Bus \_\_\_\_\_

Bus \_\_\_\_\_

Bus \_\_\_\_\_

Bus \_\_\_\_\_

Bus \_\_\_\_\_

Bus \_\_\_\_\_

# MACKIE.

The control panel is divided into several functional sections:

- Top Section:** Features two columns of channel controls. The left column has six 'LEVEL' knobs (1-6) with 'U' (up) and 'L' (down) indicators. The right column has two 'LEVEL' knobs (1-2) with 'U' and 'L' indicators, followed by 'PAN' knobs and 'ASSIGN' buttons for groups 1-2, 3-4, 5-6, and 7-8. Below these are 'PHONES 1' and 'PHONES 2' knobs, and 'L/R MIX' buttons.
- MIX B/MONITOR Section:** Includes a 'MIX-B LEVEL' knob, 'MIX-B TO L/R MIX' button, and 'ASSIGN' button.
- PHONES 1 & 2 Section:** Each has a 'MONITOR' knob, 'MIX-B' knob, 'AUX SEND 3/4' knob, and 'EXTERNAL SOURCE' button.
- MONITOR Section:** Includes 'L/R MIX', 'MIX-B', 'CNTRL RM', '3TK', 'EXTERNAL', and 'MONO SOURCE' buttons.
- SOLO Section:** Features a 'SOLO LITE' knob and 'SOLO' button.
- TALKBACK Section:** Includes 'AUX SEND 1', 'AUX SEND 2', 'TALK SUBGRPS', and 'PHONES & STUDIO' buttons.
- Meters Section:** A large central area with 24 vertical level meters. Meters 1-8 are labeled 'L' and 'R' for channels 1-8. Meters 9-24 are labeled 'L' and 'R' for channels 9-24. A 'MAIN OR SOLO LEVEL' meter is on the far right.
- Bottom Section:** Contains eight 'ASSIGN' buttons, 'MONO L/R' buttons, and 'L/R MIX' buttons for channels 1-8. Below these are eight frequency response curves (EQ) for each channel, with frequency markers at 10, 5, 20, 30, 40, and 50 kHz.

This is the back of a session note sheet,  
which came in the Mackie 8•Bus console  
manual.

If you find this sheet in a copy machine,  
please return it to the engineer/owner of  
the console.

If you find this sheet in the back of a  
gloomy tavern, buy it a cold one.

Whaddya say on the last page of a manual?  
Well, we'd like to roll the credits.

This manual is copyrighted by Mackie De-  
signs, ©1995-2003, all rights reserved.

Set in ITC Century Condensed and Adobe  
Futura Condensed via PageMaker® for the  
Macintosh®.

The bulk of this manual was written by David  
Mathew. Additional editing and sillies by Ron  
Koliha. Propellor-head technical revisions by Jeff  
Gilbert. Practical end-user revisions by Keith  
Medley. Additional enhancements by Paul

Larson and Scott Garside. Proofreading (where  
possible considering our usual state of confu-  
sion) by Linn Compton and Technical Support.

Page layout and Adobe Illustrator® technical  
drawings by Bobby Hougham, Bruce Yunker, Ron  
Koliha, Gene Endicott and Sara Drake.

Additional "help" from P.D., the Mackie  
Corporate Chihuahua who shredded several  
drawings at various points during the develop-  
ment of this manual.



# MACKIE.®

## 8•BUS LIMITED WARRANTY

Please keep your sales receipt in a safe place.

**A.** Mackie warrants all materials, workmanship and proper operation of this product for a period of **one year** from the original date of purchase. If any defects are found in the materials or workmanship or if the product fails to function properly during the applicable warranty period, Mackie, at its option, will repair or replace the product. **This warranty applies only to equipment sold and delivered within the U.S. by Mackie or its authorized dealers.**

**B.** Failure to register online or return the product registration card will not void the 1-year warranty.

**C.** Service and repairs of Mackie products are to be performed **only** at the factory (see D below) OR at an Authorized Mackie Service Center (see E below). Unauthorized service, repairs, or modification will void this warranty.

**D.** To obtain factory service:

1. Call Mackie at 800/258-6883, 8AM to 5PM Monday through Friday (Pacific Time) to get a Return Authorization (RA). Products returned without an RA number will be refused.

2. Pack the product in its original shipping carton. If you do not have the carton, just ask for one when you get your RA number, and we'll send a shipping carton out promptly. More information on packing can be found in the *Service* section of this manual. Do not use "packing peanuts," shredded newspapers, or other material with small particles, old underwear, or socks. Please seal the Mackie product in a plastic bag.

3. Also include a note explaining exactly how to duplicate the problem, a copy of the sales receipt with price and date showing, and your return street address (no P.O. boxes or route numbers, please!). If we cannot duplicate the problem at the Mackie Factory or establish the starting date of your Limited Warranty, we may, at our option, charge for service time.

4. Ship the product in its original shipping carton, **freight prepaid** to:

Mackie Designs  
Service Department  
16220 Wood-Red Rd. NE  
Woodinville, WA 98072 USA

**IMPORTANT: Make sure that the RA number is plainly written on the shipping carton.**

**E.** To obtain service from an Authorized Mackie Service Center:

1. Call Mackie at 800/258-6883, 8AM to 5PM Monday through Friday (Pacific Time) to get:

1) The name and address of your nearest Mackie Authorized Service Center and 2) A return authorization (RA). You must have an RA number before taking your unit to a service center.

2. Make sure that you have a copy of your product's sales receipt from the store where you bought the product. It is necessary to establish purchase date and thus determine whether or not your product is still under warranty. If you can't find it, the Authorized Service Center may charge you for repairs even if your product is still covered by Mackie's 3-Year Limited Warranty.

3. Make sure that the problem can be duplicated. If you bring your product to an Authorized Service Center and they can't find anything wrong with it, you may be charged a service fee.

4. If the Mackie Authorized Service Center is located in another city, pack the product in its original shipping carton. More information on packing can be found in the *Service* section of this manual.

5. Contact the Mackie Authorized Service Center to arrange service or bring the product to them.

**F.** Mackie and Mackie Authorized Service Centers reserve the right to inspect any products that may be the subject of any warranty claims before repair or replacement is carried out. Mackie and Mackie Authorized Service Centers may, at their option, require proof of the original date of purchase in the form of a dated copy of the original dealer's invoice or sales receipt. Final determination of warranty coverage lies solely with Mackie Designs Inc. or its Authorized Service Centers.

**G.** Any Mackie product deemed eligible for repair or replacement under the terms of this warranty will be repaired or replaced within thirty days of receipt by Mackie. Mackie may use refurbished parts for repair or replacement of any product. Products returned to Mackie that do not meet the terms of this Warranty will be repaired and returned C.O.D. with billing for labor, materials, return freight, and insurance. Products repaired under warranty at Mackie's factory will be returned freight prepaid by Mackie to any location within the boundaries of the USA.

**H.** Mackie warrants all repairs performed for 90 days or for the remainder of the original warranty period. Mackie assumes no responsibility for the quality or timeliness of repairs performed by Mackie Authorized Service Centers.

**I.** This warranty is extended to the original purchaser and to anyone who may subsequently purchase this product within the applicable warranty period.

**J.** This is your sole warranty. Mackie does not authorize any third party, including any dealer or sales representative, to assume any liability on behalf of Mackie Designs or to make any warranty for Mackie Designs.

**K.** THE WARRANTY GIVEN ON THIS PAGE IS THE SOLE WARRANTY GIVEN BY MACKIE AND IS IN LIEU OF ALL OTHER WARRANTIES, EXPRESS AND IMPLIED, INCLUDING THE WARRANTIES OF MERCHANTABILITY AND FITNESS FOR A PARTICULAR PURPOSE. THE WARRANTY GIVEN ON THIS PAGE SHALL BE STRICTLY LIMITED IN DURATION TO ONE YEAR FROM THE DATE OF ORIGINAL PURCHASE FROM AN AUTHORIZED MACKIE DEALER. UPON EXPIRATION OF THE APPLICABLE WARRANTY PERIOD, MACKIE SHALL HAVE NO FURTHER WARRANTY OBLIGATION OF ANY KIND. MACKIE SHALL NOT BE LIABLE FOR ANY INCIDENTAL, SPECIAL, OR CONSEQUENTIAL DAMAGES THAT MAY RESULT FROM ANY DEFECT IN THE MACKIE PRODUCT OR ANY WARRANTY CLAIM. Some states do not allow exclusion or limitation of incidental, special, or consequential damages or a limitation on how long warranties last, so some of the above limitations and exclusions may not apply to you. This warranty provides specific legal rights and you may have other rights which vary from state to state.



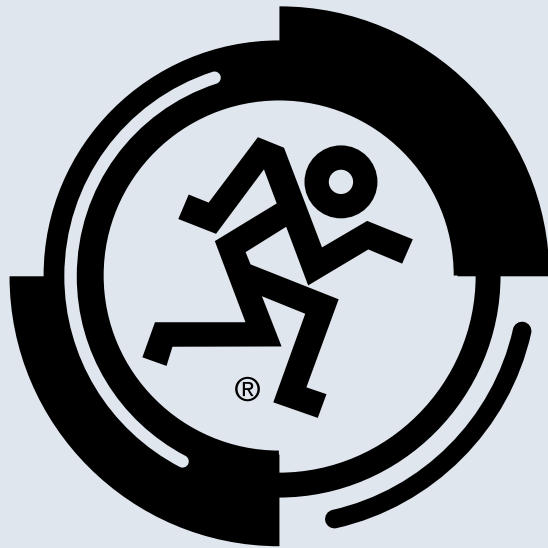

**MACKIE®.**

**Mackie Designs Inc.**

16220 Wood-Red Road NE • Woodinville, WA 98071 • USA

US and Canada: 800.898.3211

Europe, Asia, Central and South America: 425.487.4333

Middle East and Africa: 31.20.654.4000

Fax: 425.487.4337 • [www.mackie.com](http://www.mackie.com)

E-mail: [sales@mackie.com](mailto:sales@mackie.com)